



ORAC[®]
D E C O R

WALLS

the ABC
of wall
decoration



ORAC[®]
D E C O R

GIVE WALLS *PERSONALITY*

en —

Walls have power. They can be invisible, but they can be so much more. Walls tie a room together or divide it. They determine the mood of a space, whether serenity, grandeur, homeliness or festivity.

We believe walls are the most important element of an interior. And that's why we're so passionate about them. Orac Decor® builds on 50 years of history, innovation and quality to revive heritage and create the walls of the future. Let us share our passion with you.

ru —

У стен есть сила. Они могут быть невидимыми, а могут бросаться в глаза. Стены могут объединять комнату или разделять ее. Они могут задавать настроение помещения, будь то безмятежность, величие, уют или праздник.

Мы считаем, что стены – самый важный элемент интерьера. Именно поэтому мы так их любим. Компания Orac Decor® опирается на 50-летнюю историю, инновации и качество, чтобы возродить старое наследие и создать стены будущего. Позвольте поделиться с вами нашей страстью.

pl —

Ściany mają moc. Mogą być niedostrzegalne, ale mogą też zaoferować o wiele więcej. Ściany mogą spajać wnętrze lub dzielić je. Mogą stworzyć odpowiedni nastrój w pomieszczeniu, czy to spokojny, dostojny, przytulny czy uroczysty.

Wierzymy, że ściany są najważniejszym elementem wnętrza. Właśnie dlatego pasjonujemy się nimi. Firma Orac Decor® od 50 lat stawia na innowacyjność i jakość, aby ożywić dziedzictwo dawnych czasów i stworzyć ściany przyszłości. Pragniemy podzielić się z Tobą naszą pasją.

ar —

للجدران قوتها الخاصة. فقد تكون غير مرئية، ولكن يمكنها أن تكون أكثر من ذلك بكثير. فالجدران يمكنها أن تربط أجزاء الغرفة معاً أو تقوم بتقسيمها. ويمكنها أن تحدد الطابع العام لإحدى المساحات، سواء كان ذلك الطابع هو الهدوء أو الفخامة أو البساطة أو البهجة.

نحن مؤمنون بأن الجدران هي العنصر الأهم في التصميم الداخلي. ولذلك فإننا نشغوفون جداً بها. بتاريخها الممتدة جذوره إلى 50 عاماً من الابتكار والجودة، تسعى Orac Decor® لإحياء التراث العريق وإنشاء جدران المستقبل. دعنا نشارك شغفنا معك.

fr —

Les murs ont de l'énergie. Ils peuvent être invisibles, mais ils peuvent être bien plus. Les murs peuvent relier une pièce ou la diviser. Ils peuvent déterminer l'ambiance d'un espace, qu'il s'agisse de sérénité, de grandeur, de convivialité ou de festività.

Nous pensons que les murs sont l'élément le plus important d'un intérieur. C'est pourquoi ils nous passionnent. Orac Decor® s'appuie sur 50 ans d'histoire, d'innovation et de qualité pour revitaliser l'héritage ancien et créer les murs de l'avenir. Laissez-nous partager notre passion avec vous.

Content

ru —

06	The wall says it all
20	Зал
24	Гостиная
32	Кухня
38	Спальня
44	Ванная комната
50	Бар Ресторан Отель
58	Материалы
60	Ассортимент
62	Карнизы
88	Плинтусы
104	Молдинги
116	3D Стеновые покрытия
130	Скрытое освещение
144	Декоративные элементы
154	Идеальный финиш
156	Гибкие профили

ar —

The wall says it all	06
مدخل	20
صالون	24
مطبخ	32
غرفة نوم	38
حمام	44
شريط مطعم الفندق	50
المواد	58
نظرة عامة على المنتجات	60
كرانيش	62
نعلات	88
قوالب للجدران	104
تغطية جدار	116
إضاءة غير مباشرة	130
أصناف للزينة	144
مظهر نهائي مثالي	154
المنتجات المرنة	156



en —

06	The wall says it all
20	Hall
24	Living room
32	Kitchen
38	Bedroom
44	Bathroom
50	Bar Restaurant Hotel
58	Materials
60	Product Overview
62	Cornices
88	Skirting Boards
104	Panel Mouldings
116	3D Wall Covering
130	Led Coving
144	Deco Elements
154	The Perfect Finish
156	Flexible products

pl —

06	The wall says it all
20	Hol
24	Pokój dzienny
32	Kuchnia
38	Sypialnia
44	Łazienka
50	Bar Restauracja Hotel
58	Materiały
60	Przegląd Produktów
62	Gzymsy
88	Listwy przypodłogowe
104	Profile ścienne
116	Panele 3D
130	Listwy oświetleniowe
144	Elementy dekoracyjne
154	Idéalne Wykończenie
156	Produkty Elastyczne

fr —

06	The wall says it all
20	Hall
24	Séjour
32	Cuisine
38	Chambre à coucher
44	Salle de bains
50	Bar Resto Hotel
58	Matériaux
60	Aperçu Produits
62	Corniches
88	Plinthes
104	Cimaises
116	Revêtements muraux 3D
130	Eclairage Indirect
144	Eléments Décoratifs
154	La Finition Parfaite
156	Produits Flexibles

The wall says it all

ru —

Осмотрите наш House of Personality. Дайте волю фантазии, переходя из спальни в ванную комнату и из кухни в гостиную. Представьте, что вы подружились со своими стенами. Что вас вдохновит сегодня?

pl —

Odkryj nasz Dom osobowości. Z sypialni do łazienki i z kuchni do salonu – daj się ponieść swojej kreatywności. Wyobraź sobie, że ściany mogą odzwierciedlić Twoją osobowość. Co Cię zainspiruje dzisiaj?

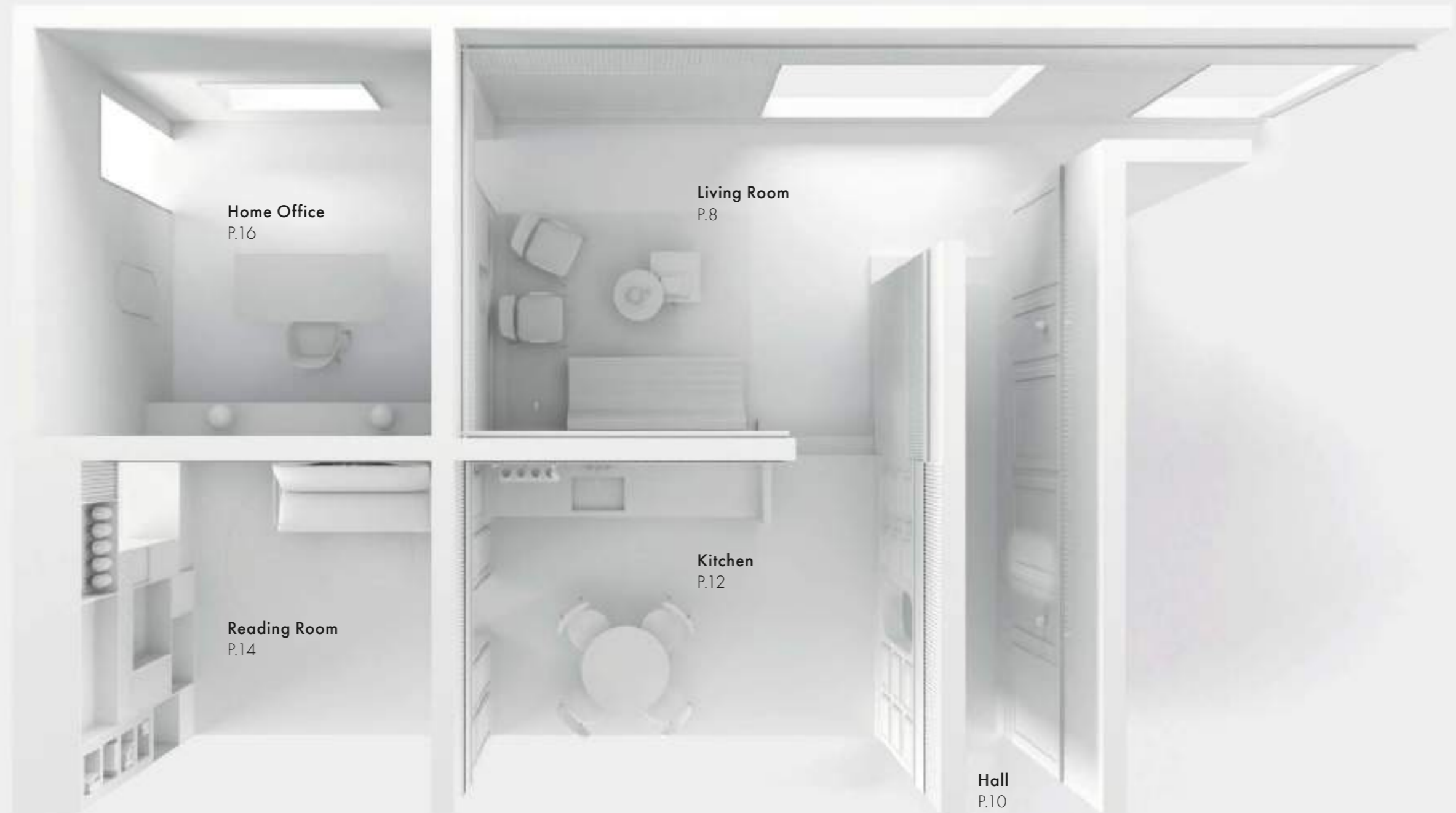

6

7

House of Personality

Explore our House of Personality.

Let your creativity take over as you move from bedroom to bathroom and from kitchen to living room. Imagine injecting your personality on the walls. What will inspire you today?

ar —

استكشف تصميم House of Personality الخاص بنا. دع خيالك يتصور رحلتك الصغيرة من غرفة النوم إلى الحمام ومن المطبخ إلى غرفة المعيشة. تخيل جدراناً مرسومة بأبعاد شخصيتك. ما الذي سيلهمك اليوم؟

fr —

Explorez notre maison des personnalités. Laissez libre cours à votre créativité lorsque vous passez de la chambre à coucher à la salle de bains et de la cuisine au salon. Imaginez que vous projetiez votre personnalité sur les murs. Qu'est-ce qui vous inspirera aujourd'hui ?

Discover our
House of
Personality



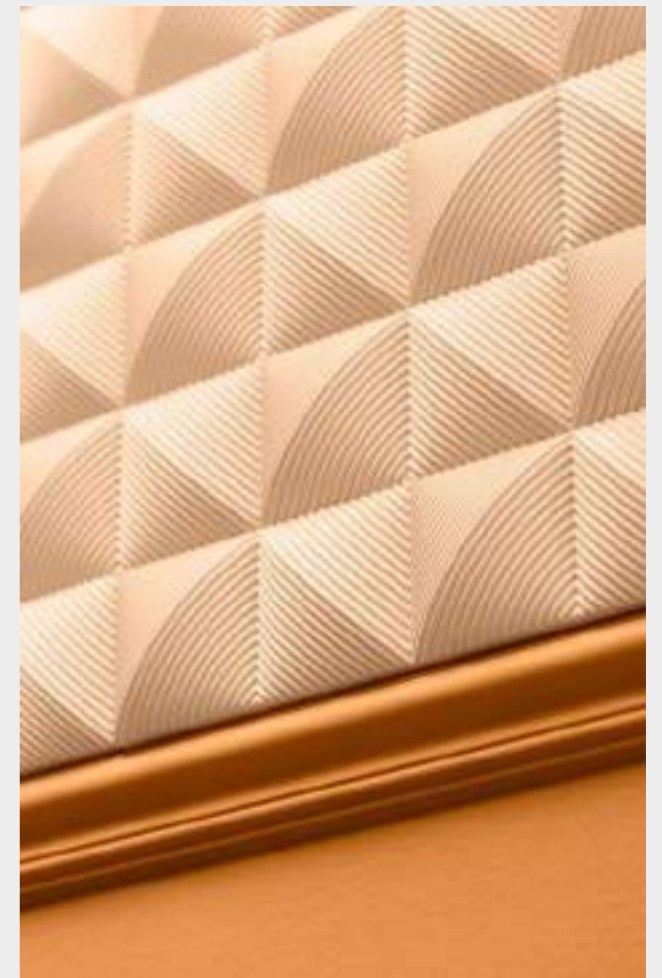
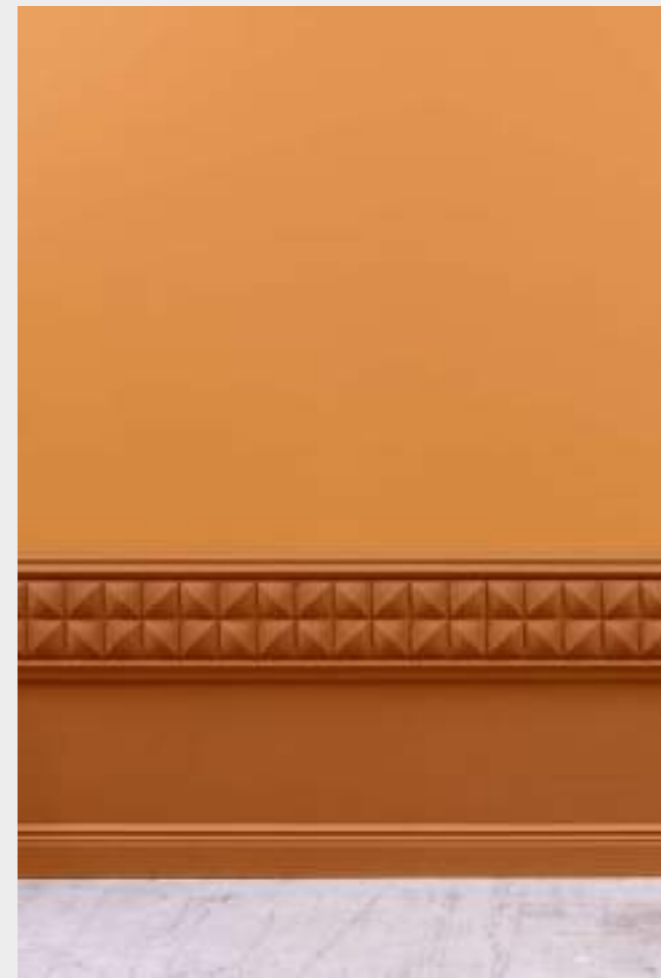

Wall structure and surface textures are combined to create this **relaxing living room**.



ru —

Сочетание структуры стен и текстуры поверхности создает в гостиной расслабляющую атмосферу.

ar —

تتناغم بنية الجدران مع قوام الأسطح لتجعل غرفة المعيشة هذه باعثة على الاسترخاء.

pl —

Ten relaksujący salon istnieje dzięki połączeniu struktury ściany z fakturą na jej powierzchni.

fr —

La structure du mur et les textures de surface sont combinées pour créer ce salon relaxant.



Strong patterns
and graphic lines
transform a dull
passage into an
eye-catching
entrance.



ru —

Эффектные узоры и графические линии мгновенно превращают темное и скучное пространство в привлекательную прихожую.

pl —

Wyrziste wzory i graficzne linie od razu zmieniają ciemną i nudną przestrzeń w atrakcyjny wizualnie korytarz.

ar —

للأتماط البارزة والخطوط الحيوية القدرة على تحويل الطابع المظلم والممل لتلك المساحة إلى ردهة ذات تصميم جذاب.

fr —

Des motifs et des lignes graphiques puissants transforment immédiatement un espace sombre et ennuyeux en couloir attirant.

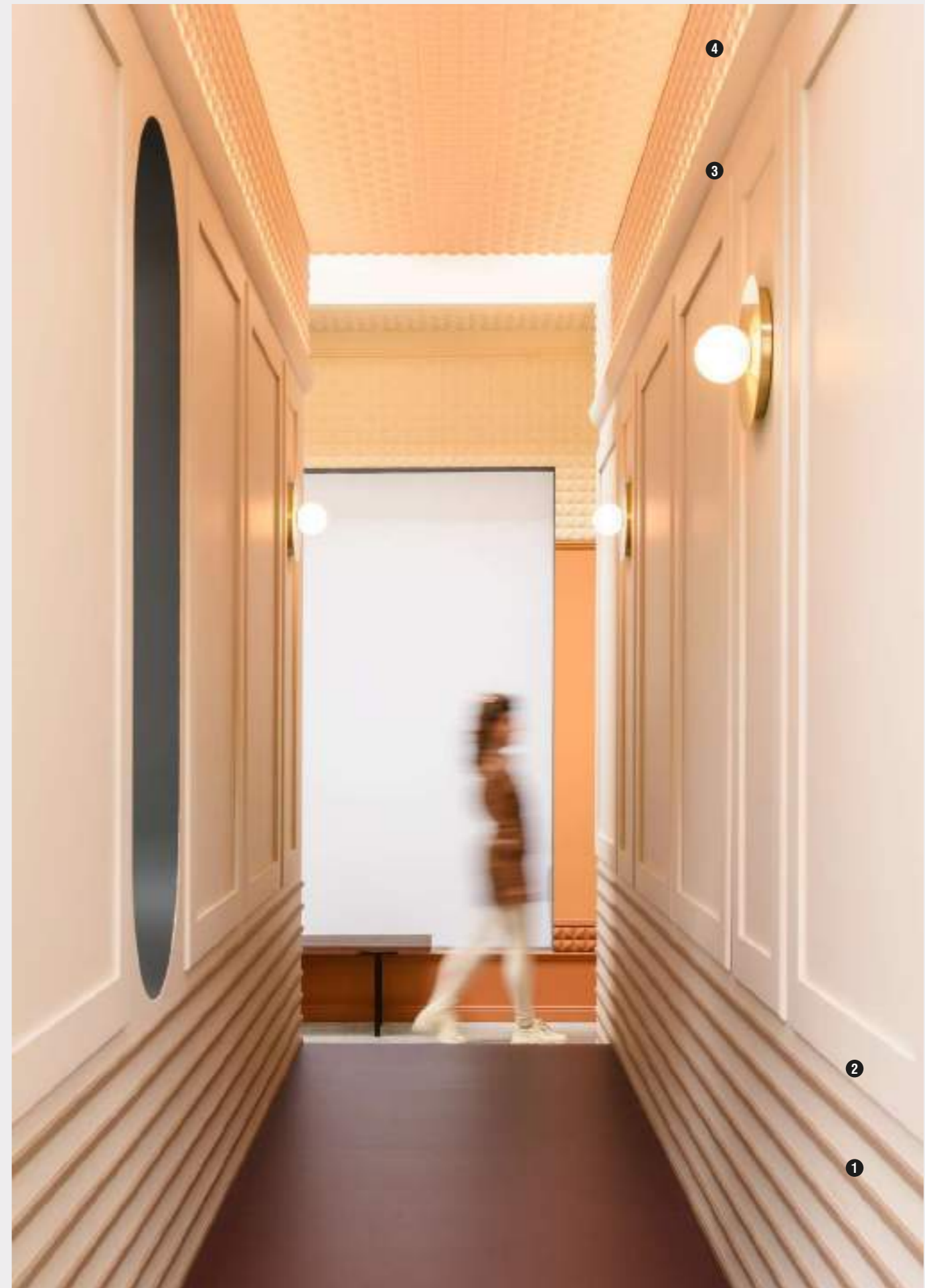

Unconventional combinations in our cosmopolitan kitchen bring daily inspiration.

ru —

Необычные сочетания в нашей космополитичной кухне – источник вдохновения на каждый день.

ar —

التكوينات غير التقليدية الممتزجة في مطبخنا العالمي هي مصدر يومي للإلهام.

pl —

Niekonwencjonalne połączenia w naszej kosmopolitycznej kuchni stanowią źródło inspiracji na co dzień.

fr —

Les combinaisons non conventionnelles dans notre cuisine cosmopolite sont une source d'inspiration quotidienne.



12

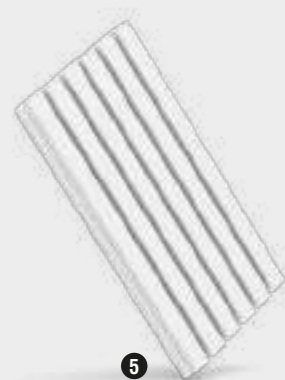

13

Kitchen



14



1. W110 p.118 | 2. W108 p.118 | 3. W112 p.122 | 4. W130 p.120 | 5. W109 p.118 | 6. W111 p.118 | 7. W113 p.122 | 8. CX190 p.98

ru —

Линейная, изогнутая или с узорами. Формы в этой эклектичной комнате для чтения вдохновляют меня на самовыражение.

ar —

أشكال خطية أو مزخرفة أو ذات انحناءات. مُدني الأشكال التي تقع عليها عيني في غرفة القراءة الاستثنائية هذه بالقوة للتعبير عن ذاتي.

pl —

Proste, zakrzywione lub ozdobne. Kształty w tej ekлекtycznej bibliotece dodają mi energii i pozwalają wyrażać siebie.

fr —

Linéaire, courbée ou décorée. Les formes de cette salle de lecture éclectique me donnent énergie et créativité.

Linear, curved or ornamented. The variety of shapes in this **eclectic reading room** energise me to express myself.

15 —
Reading room

Welcome to my urban business environment where linear repetition creates a structured and organized finish.



1. SX157 p.102 | 2. W112 p.122 | 3. SX194 p.113

ru —

Добро пожаловать в мой городской деловой дворец, где тонкие линейные повторы дают структурированный и организованный результат.

pl —

Witaj w moim miejskim pałacu biznesu, gdzie dzięki subtelnym linearnym powtórzeniom wszystko jest uporządkowane i zorganizowane.

ar —

مرحبًا بكم في قصري المتواضع حيث أؤدي عملي وسط تصميم دقيق من أنماط خطية متكررة تضيف روحًا من الجدية والتنظيم.

fr —

Bienvenue dans mon palais des affaires urbaines où des répétitions linéaires subtiles créent un résultat structuré et organisé.

For the love of walls

Inspiring projects bursting with personality

ru —

Из любви к стенам – вдохновляющие проекты, пронизанные индивидуальностью.

pl —

Z miłości do ścian – inspirujące projekty wyrażające osobowość projektanta.

ar —

شغف بالجدران - مشروعات ملهمة تنطق بتفرد شخصياتها.

fr —

Pour l'amour des murs – Des projets inspirants pleins de personnalité.

18



Hallway



Living Room



Kitchen



Bathroom



Bedroom



Bar | Resto | Hotel

19

Projects overview

Walls should inspire us,



1. SX163 p.102 | 2. C396 p.77

not limit us



3. SX163 p.102 | 4. P8030 p.106 | 5. C341 p.64

ru —

Стены должны нас вдохновлять,
а не ограничивать.

pl —

Ściany powinny nas inspirować,
a nie ograniczać.

ar —

الجدران من شأنها أن تلهمنا، لا أن تقيدنا.

fr —

Les murs devraient nous inspirer
et non nous limiter.

Before ...



& after

Instant replay.

Install profiles in repetitive sequences to give your hall depth and structure.

ru —

Мгновенный отклик. Используйте профили в повторяющейся последовательности, чтобы придать вашей прихожей впечатляющую глубину и структуру.

ar —

فقط تصميمي متكرر. استخدم الأنماط التصميمية في تسلسل تكراري لتمنح ردهتك على الفور بنية وعمقًا.

pl —

Błyskawiczne powtórki. Stosuj profile w powtarzającej się kolejności, aby natychmiast nadać swojemu korytarzowi głębię i strukturę.

fr —

Répétition instantanée. Utilisez les profilés dans une séquence répétitive pour donner une profondeur et une structure immédiates à votre couloir.

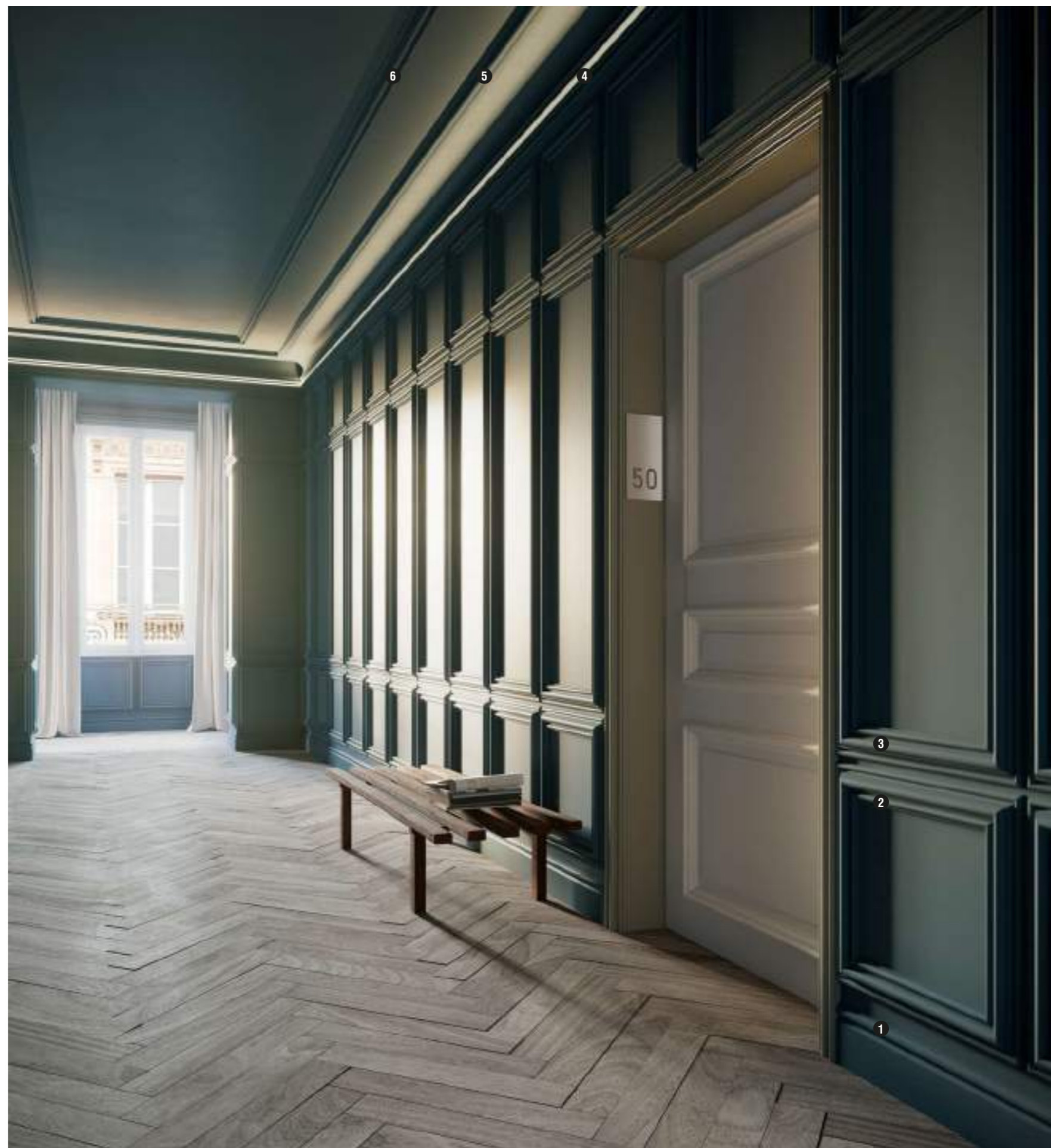

Walls are not supposed to be boring



24

ru —
Стены не должны быть скучными.

ar —
لم تُصنع الجدران لتُشعرنا بالرتابة.

pl —
Ściany nie muszą być nudne.

fr —
Les murs ne sont pas faits pour être ennuyeux.



25

Living Room projects



1. SX163 p.102 | 2. P8030 p.106 | 3. C338 p.66 | 4. C338A p.66 | 5. C338B p.66

26



1. SX163 p.102 | 2. C396 p.77



3. SX118 p.93 | 4. P8020 p.106 | 5. C342 p.64

27

Living Room projects

Composed elegance.
Combine multiple cornice mouldings to create a beautiful transition from wall to ceiling.

ru —

Элегантность в сочетании. Сочетание нескольких карнизов и профилей создает уникальный эффект перехода между стеной и потолком.

pl —

Oranowana elegancja. Połącz kilka listew i gzymsów, aby uzyskać unikalny efekt przejścia ze ściany na sufit.



1. SX156 p.95 | 2. P8030 p.106 | 3. P8020 p.106 | 4. DX170-2300 p.150 | 5. C362 p.142 | 6. P9901 p.108 | 7. C342 p.81 | 8. P8050 p.106

ar —

أنافة تناغمية. ادمج العديد من قوالب الإفريز والأعاط التصميمية لإبداع ذلك التأثير الفريد للانتقال من الجدار إلى السقف.

fr —

Une élégance composée. Combinez plusieurs corniches et profils pour créer un effet de transition unique entre le mur et le plafond.



GIVE WALLS *PERSONALITY*

CLASSIC



30

MODERN



ZEN



ECLECTIC



31
Living Room projects



Let your
walls
do the
talking



1. W110F p.118 | 2. W110 p.118 | 3. W121 p.126 | 4. W123 p.126 | 5. W120 p.126 | 6. W122 p.126

ru —

Пусть ваши стены говорят сами за себя.

pl —

Niech ściany mówią same za siebie.

ar —

دع جدرانك تتحدث عنك.

fr —

Laissez vos murs parler.



1. SX155 p.96 | 2. D330LR p.150 | 3. DX170-2300 p.150 | 4. C342 p.64



Before ...



36

Highlight the ceiling.

Use led coving for a more spacious effect.

ru —

Подсветите потолок. Используйте скрытое освещение, расширяя ощущение пространства.

pl —

Podkreśl sufit. Korzystaj z oświetlenia pośredniego, aby uzyskać efekt większej przestrzeni.

ar —

أبرز السقف بالإضاءة. استخدم الإضاءة غير المباشرة للحصول على تأثير أكثر اتساعًا.

fr —

Faites ressortir le plafond. Utilisez un éclairage indirect pour un effet plus spacieux.

& after



37

Kitchen projects —



1. PX102 p.111 | 2. PX175 p.111 | 3. SX118 p.93 | 4. PX103 p.111

Walls deserve personality

ru —
Стены заслужили быть индивидуальными.

pl —
Ściany zasługują na osobowość.

ar —
تستحق الجدران أن تحظى بشخصيتها الخاصة.

fr —
Les murs méritent une vraie personnalité.



1. SX162 p.102 | 2. C396 p.77

Combine modern and classic.

Discover how traditional skirting boards and wall mouldings perfectly complement a contemporary cornice.



3. SX163 p.102 | 4. P8030 p.106 | 5. P8050 p.106 | 6. C393 p.77

ru —

Сочетайте современность и классику. Узнайте, как традиционные плинтусы и молдинги идеально дополняют современный карниз.

ar —

اجمع بين العصري والكلاسيكي. اكتشف كيف يمكن للوزرات وقوالب الجدران التقليدية أن تتوافق بمثالية مع الأفاريز العصرية.

pl —

Nowoczesność i klasyka w jednym. Zobacz, jak tradycyjne listwy przypodłogowe i listwy ściienne doskonale komponują się ze współczesnym gzymsem.

fr —

Combinez modernité et classicisme. Découvrez comment les plinthes et les cimaises traditionnelles complètent parfaitement une corniche contemporaine.

GIVE WALLS
PERSONALITY

ZEN



42

CLASSIC



ECLECTIC



43

Bathroom projects —

MODERN



Bring your walls



to life

ru —

Пусть ваши стены оживут.

pl —

Niech Twoje ściany ożyją.

ar —

دع جدرانك تنبض بالحياة.

fr —

Donnez vie à vos murs.



1. SX118 p.93 | 2. PX103 p.111 | 3. C343 p.64



Well-dressed windows.

Use our curtain profiles to hide your curtain rails in an instant for non-stop elegance.



3. C342 p.81



ru —

Продуманное оформление окон. С помощью профилей для штор можно скрыть карнизы, чтобы придать окнам элегантность.

pl —

Okna o eleganckim wyglądzie. Nasze profile umożliwiają ukrycie karniszy, natychmiast dodając elegancji.

ar —

نوافذ أنيقة. استخدم أمطنا التصميمية للستائر لإخفاء قضبان الستائر من أجل الحصول على أناقة فورية.

fr —

Des fenêtres bien habillées. Utilisez nos profils de rideaux pour cacher vos tringles afin d'obtenir une élégance instantanée.

GIVE WALLS *PERSONALITY*

MODERN



48

CLASSIC



ECLECTIC



ZEN



49
Bedroom projects



50



1. W109 p.118 | 2. W109F p.118 | 3. SX105 p.96 | 4. P7070 p.108 | 5. SX187 p.102



ru —

Каждая стена – это приглашение создавать красоту.

pl —

Każda ściana to zaproszenie do tworzenia piękna.

ar —

كل جدار هو فرصة لإضفاء الجمال.

fr —

Chaque mur est une invitation à créer de la beauté.

Every wall is an invitation
to create beauty

51



1. P3020 p.107 | 2. P3020A p.115 | 3. P8040 p.106 | 4. SX118 p.93 | 5. P8020 p.106 | 6. P8030 p.106 | 7. C343 p.81

ru —

Мгновенный эффект.
Вы любите эффект Wainscoting из панелей и хотите быстро приступить к работе? Готовые панели устанавливаются прямо на стену без каких-либо подготовительных работ.

ar —

تأثير رائع.
تلييسة عالية في أي وقت من الأوقات. يمكن تركيب الألواح الجاهزة للاستخدام مباشرة على الجدران الخاصة بك دون تحضير.

pl —

Efekt natychmiastowy.
Wysoka boazeria w mgnieniu oka. Te prefabrykowane panele mogą być montowane bezpośrednio na ścianie bez żadnych prac przygotowawczych.

fr —

Grand effet.
Des lambris hauts en un rien de temps. Les panneaux prêts à l'emploi peuvent être installés directement sur vos murs sans preparation.



Immediate effect.
Tall wainscoting in no time. These pre-fabricated panels can be mounted directly to the wall without any prep work.



1. SX191 p.95 | 2. W121 p.126 | 3. W120 p.126 | 4. C324 p.132 | 5. C990 + P9900 p.75



56



1. SX168 p.102 | 2. SX162 p.113

57

Engineered Materials

ВЫСОКОТЕХНОЛОГИЧНЫЕ МАТЕРИАЛЫ / MATERIAŁY TECHNICZNE
مواد مصممة هندسيًا / MATÉRIAUX TECHNIQUES

PUROTOUCH[®]

A high-quality, high-density polyurethane that allows fine details.

Высококачественный полиуретан высокой плотности позволяет создавать мелкие детали.

Wysokiej jakości, o dużej gęstości poliuretan pozwala uzyskać drobne szczegóły.

بوليوريثين عالي الجودة، عالي الكثافة يسمح بالحصول على تفاصيل دقيقة.

Un polyuréthane de qualité à haute densité qui permet de créer des détails fins.

Detail Design ★ ★ ★
Impact Resistance ★ ★



DUROPOLYMER[®]

An extruded and impact-resistant polymer based on a high-density polystyrene.

Экструдированный и ударопрочный полимер на основе полистирола высокой плотности.

Tłoczony, odporny na uderzenia polimer powstały na bazie polistyrenu o wysokiej gęstości.

بوليمر مبثوق ومقاوم للصدمات، من مزيج بوليستيرين عالي الكثافة.

Un polymère extrudé résistant aux impacts à base d'un mélange de polystyrènes haute densité.

Detail Design ★ ★
Impact Resistance ★ ★ ★



DUROFOAM[®]

An extruded lightweight polymer based on a medium-density polystyrene blend.

Экструдированный легкий полимер на основе полистирольной смеси средней плотности.

Lekki, tłoczony polimer na bazie mieszanki polistyrenów o wysokiej gęstości.

بوليمر مبثوق وخفيف الوزن، من مزيج بوليستيرين متوسط الكثافة.

Un polymère léger extrudé à base d'un mélange de polystyrènes de densité moyenne.

Detail Design ★
Impact Resistance ★

Advantages

ПРЕИМУЩЕСТВА / ZALETY / المميزات / AVANTAGES

READY TO PAINT

All of our products are ready to paint. RAL-colours on demand.

Вся наша продукция готова к покраске.

Wszystkie nasze produkty są gotowe do malowania. Kolory RAL dostępne na życzenie.

جميع منتجاتنا جاهزة للطلاء. ألوان LAR متوفرة عند الطلب.

Tous nos produits sont prêts à peindre. Couleurs RAL sur demande.



DURABLE

Orac Decor[®] products are designed to last a lifetime. Smart design and high-end technology assure strong and water resistant products.

Продукция Orac Decor[®] рассчитана на долгий срок службы. Продуманная конструкция и передовые технологии обеспечивают прочность и водостойкость изделий.

Produkty Orac Decor[®] zostały zaprojektowane z myślą o wieloletniej trwałości. Przemysłowy projekt i najnowocześniejsza technologia zapewniają wytrzymałość i wodoodporność naszych produktów.

صُممت منتجات Orac Decor[®] لتدوم مدى الحياة. يضمن التصميم الذكي والتكنولوجيا فائقة التطور الحصول على منتجات قوية ومقاومة للماء.

Les produits Orac Decor[®] sont conçus pour durer toute une vie. Une conception intelligente et une technologie haut de gamme garantissent des produits robustes et résistants à l'eau.



LEGEND



SX118 | SX118F | SX118 - RAL9003
200 x 13,8 x 1,8 cm
Duropolymer[®]

F = Flexible polyurethane version
RAL 9003 = Finished with RAL9003 (white, on stock)
Dimensions
Material

Product Overview



Cornice Mouldings

Карнизы / Gzymsy / كرانيش / Corniches

Pg.62



Skirting Boards

Плинтусы / Listwy Przypodłogowe
نعلات / Plinthes

Pg.88



Panel Mouldings

Молдинги / Profile Ścienne
قوالب للجدران / Cimaises

Pg.104



3D Wall Covering

3D Стеновые покрытия / Panele 3D
إضاءة غير مباشرة / Revêtements muraux 3D

Pg.116



Led Coving

Скрытое освещение / Listwy Oświetleniowe
إضاءة غير مباشرة / Éclairage Indirect

Pg.130



Deco Elements

Декоративные элементы / Elementy dekoracyjne
أصناف للزينة / Éléments Décoratifs

Pg.144

The Perfect Finish

Идеальный Финиш / Idealne Wykończenie / مطهر نهائي مثالي / La Finition Parfaite

Pg. 154



Cornice Mouldings

КАРНИЗЫ / GZYMSY
كرانيش / CORNICHES



en —

Your walls don't stop when they touch the ceiling. Add a splash of your personality to this transition area – and let it continue onto the ceiling with our cornice mouldings. Available in a range of styles from sleek to baroque, from decorative to functional.

ru —

Стены не завершаются,, примыкая к потолку. Наши карнизы придадут этому переходу индивидуальности и плавно продолжат декор уже на потолке. Доступен широкий диапазон стилей – от гладких до барокко, от декоративных до функциональных.

pl —

Twoje ściany nie kończą się, gdy dotkną sufitu. Wyraż swoją osobowość, kształtując ten odcinek przejściowy aż do sufitu z pomocą naszych gzymsów. Dostępne w wielu stylach, od eleganckich po barokowe, od dekoracyjnych po funkcjonalne.

ar —

لا تتوقف جدرانك عند ملاستها للسقف. أضف لمسة من شخصيتك على هذه المساحة الانتقالية ودعها تمتد إلى السقف مع قوالب الإفريز الخاصة بنا. وهي متوفرة في مجموعة من الأنماط تمتد من البسيط إلى الباروكي، ومن المزخرف إلى العملي.

fr —

Vos murs ne s'arrêtent pas lorsqu'ils arrivent au plafond. Ajoutez une touche de personnalité à cette zone de transition et laissez-la continuer vers le plafond avec nos corniches. Disponible dans une gamme de styles allant du style épuré au baroque, du style décoratif au style fonctionnel.



C325 | C325F MANOIR
200 x 7 x 6,5 cm
Purotouch®

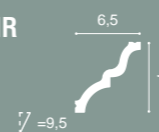

C326 | C326F MANOIR
200 x 10,5 x 9 cm
Purotouch®



9 C327 MANOIR
200 x 14,3 x 15,9 cm
Purotouch®

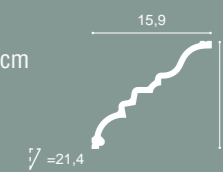

64



C341 | C341F HERITAGE
200 x 8,8 x 12,2 cm
Purotouch®

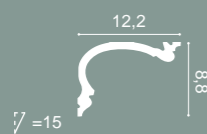

C342 HERITAGE
200 x 14 x 19 cm
Purotouch®



C343 HERITAGE
200 x 19 x 25 cm
Purotouch®

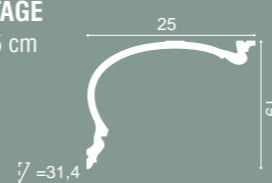

4 C344 HERITAGE
200 x 27,3 x 35 cm
Purotouch®



65



C230 | C230F
200 x 2,9 x 2,9 cm
Purotouch[®]

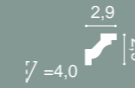

C215 | C215F
200 x 4,7 x 4,7 cm
Purotouch[®]

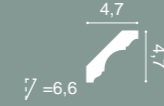

C322
200 x 5 x 4,2 cm
Purotouch[®]



C200
200 x 6,5 x 5,7 cm
Purotouch[®]



C220 | C220F
200 x 7,6 x 11,6 cm
Purotouch[®]

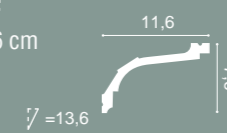

C213 | C213F
200 x 8 x 8 cm
Purotouch[®]



C217 | C217F
200 x 10,3 x 15,6 cm
Purotouch[®]

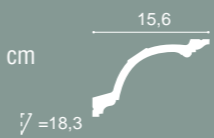

C217 | C217F
200 x 15,6 x 10,3 cm
Purotouch[®]

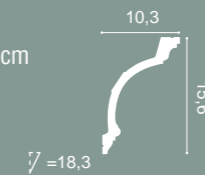

C216
200 x 11,6 x 13,3 cm
Purotouch[®]

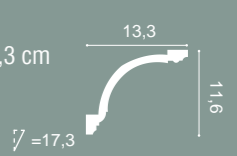

C301
200 x 17 x 14,4 cm
Purotouch[®]

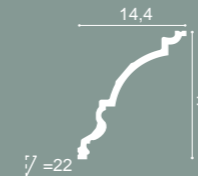

2 C338 BA'ROCK
200 x 18,2 x 18,2 cm
Purotouch[®]

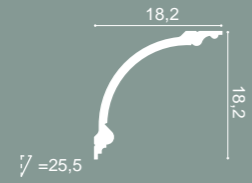

C336 BA'ROCK
200 x 27,1 x 26,6 cm
Purotouch[®]

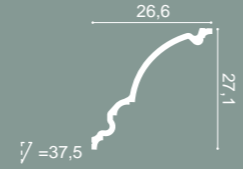

3 C338B BA'ROCK
200 x 18,2 x 18,2 cm
Dessin: 2 x 57 cm
Purotouch[®]

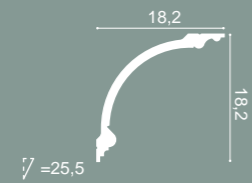

1 C338A BA'ROCK
200 x 18,2 x 18,2 cm
Dessin: 120 cm
Purotouch[®]

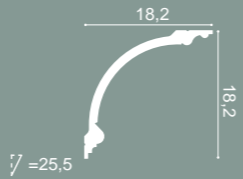



C333 | C333F
200 x 12,2 x 11,1 cm
Purotouch®
11,1
12,2
∇ = 16,2



C331 | C331F
200 x 6,4 x 13,5 cm
Purotouch®
13,5
6,4
∇ = 14,5

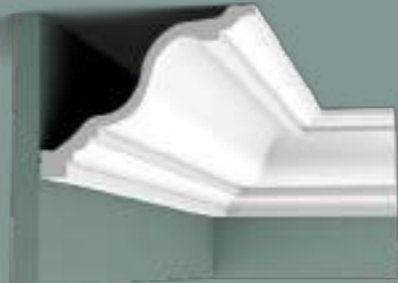

C334 | C334F
200 x 15 x 19,6 cm
Purotouch®
19,6
15
∇ = 24,1



C335
200 x 20,2 x 22,2 cm
Purotouch®
22,2
20,2
∇ = 29,3
Designed by
Xavier Donck



C335
200 x 22,2 x 20,2 cm
Purotouch®
20,2
22,2
∇ = 29,3
Designed by
Xavier Donck



C902 | C902F
200 x 10,3 x 10,3 cm
Purotouch®
10,3
10,3
∇ = 14,2



C901 | C901F
200 x 14,8 x 12,4 cm
Purotouch®
12,4
14,8
∇ = 19,2



C900
200 x 17,1 x 14,6 cm
Purotouch®
14,6
17,1
∇ = 21,8

68



1. SX156 p.95 | 2. P8020 p.106 | 3. C901 p.68

69



C305
200 x 4,7 x 15,5 cm
Purotouch®
15,5
4,7
5,6
15,9



C305 + C213
15,5
4,7
8
8
19,3



C305 + C211
15,5
4,7
11,6
11,2
21,5



C212
200 x 7,5 x 4,5 cm
Purotouch®
4,5
7,5
8,5



C201
200 x 11,6 x 4,8 cm
Purotouch®
4,8
11,6
12,5



C304 | C304F
200 x 12,2 x 7,2 cm
Purotouch®
7,2
12,2
13,9



C211 | C211F
200 x 11,6 x 11,2 cm
Purotouch®
11,2
11,6
15,8



C422
200 x 16,4 x 19,4 cm
Purotouch®
19,4
16,4
25,4



C303
200 x 14,4 x 6,5 cm
Purotouch®
6,5
14,4
15,3



4 C219
200 x 17,6 x 13 cm
Purotouch®
13
17,6
21,8



C308
200 x 24,8 x 6,3 cm
Purotouch®
6,3
24,8
25

70



C307
200 x 19,5 x 19,5 cm
Purotouch®
19,5
19,5
26,5



1 C307 + C307A 2
C307A: 7,5 x 4 x 9,4 cm
Duropolymer®
19,5
9,4
4
26,9



3. P8020 p.106 | 4. C219 p.71

71



C321 | C321F
200 x 9,9 x 5 cm
Purotouch®

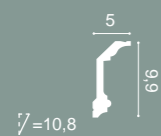

C339 | C339F
200 x 14,1 x 6,4 cm
Purotouch®

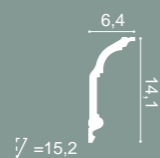

4 C332
200 x 23 x 11,4 cm
Purotouch®

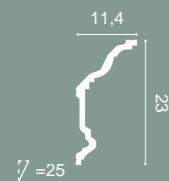

C332
200 x 11,4 x 23 cm
Purotouch®



C340
200 x 25,6 x 13,5 cm
Purotouch®

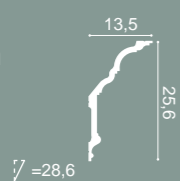

C340
200 x 13,5 x 25,6 cm
Purotouch®

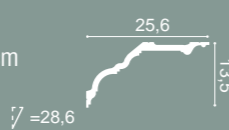

1. SX156 p.95 | 2. DX170-2300 p.150 | 3. C323 p.132 | 4. C332 p.72



C250 | C250F
200 x 1,6 x 1,6 cm
Purotouch®

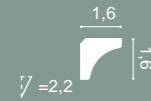

C260
200 x 4,1 x 4,8 cm
Purotouch®

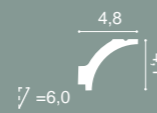

C240 | C240F
200 x 8 x 8 cm
Purotouch®

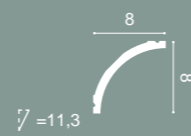

C991
200 x 11 x 14 cm
Purotouch®
Designed by Ulf Moritz

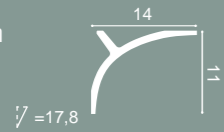

C991 + P9900

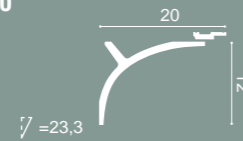

C991 + 2x P9900

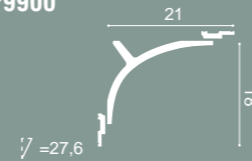

C991
200 x 14 x 11 cm
Purotouch®
Designed by Ulf Moritz

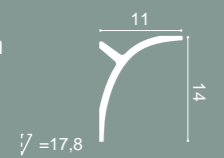

C991 + P9900

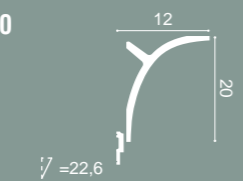

C991 + 2x P9900

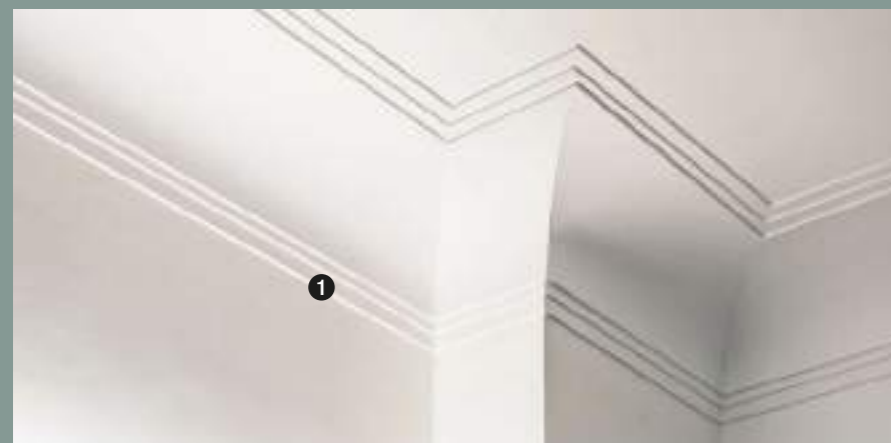
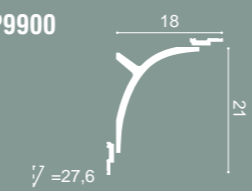

1. C991 + 2x P9900 p.75

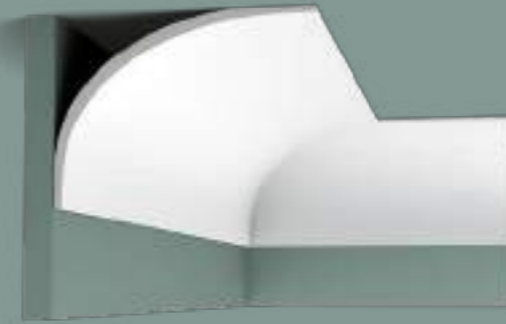

C990 INFINITY
200 x 15,9 x 21,6 cm
Purotouch®
Designed by Xavier Donck

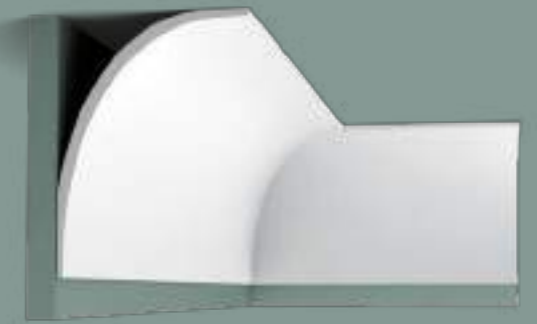
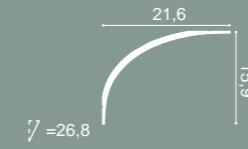

C990 INFINITY
200 x 21,6 x 15,9 cm
Purotouch®
Designed by Xavier Donck



C990 + P9900

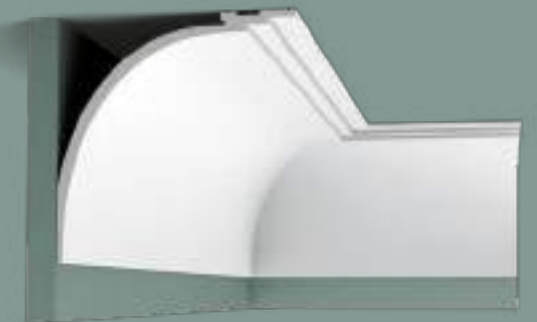
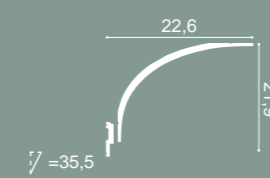

C990 + P9900

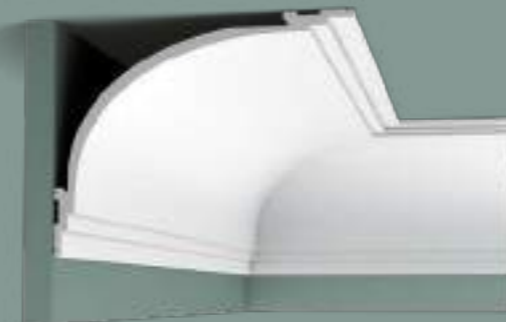
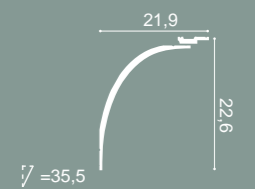

C990 + 2x P9900

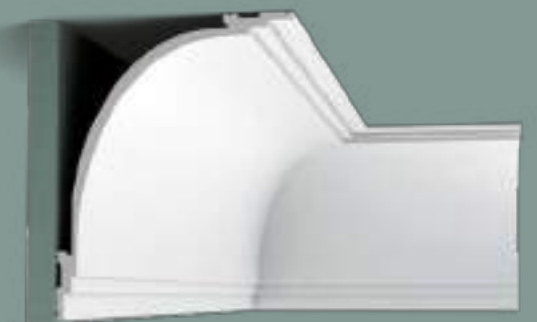
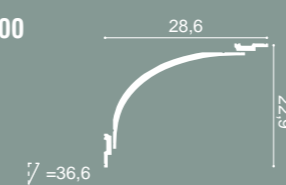

1 C990 + 2x P9900

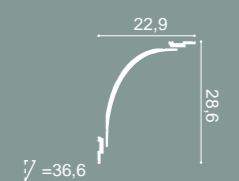

Steps



C394 STEPS
200 x 3,1 x 9,5 cm
Purotouch®
Designed by
Orio Tonini

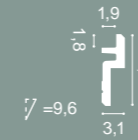

C395 STEPS
200 x 3,1 x 15,5 cm
Purotouch®
Designed by
Orio Tonini

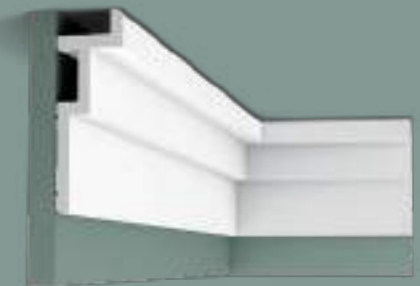

C396 STEPS
200 x 6,1 x 18,5 cm
Purotouch®
Designed by
Orio Tonini

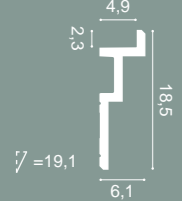

CORNICE MOULDINGS | КАРНИЗЫ | GZYMSY | کرانیس | CORNICHES

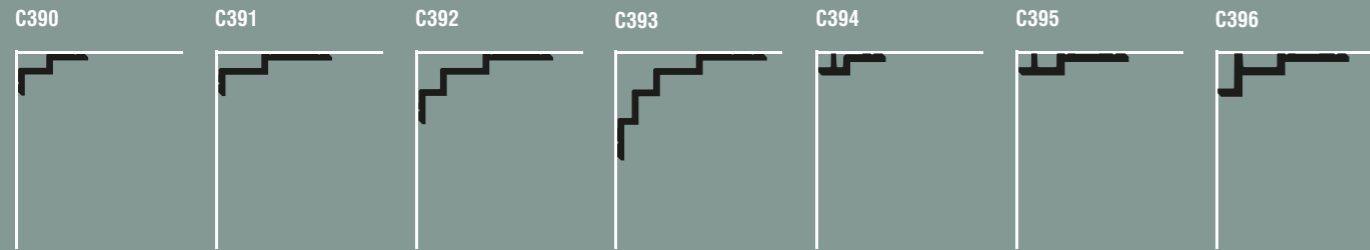

C390 STEPS
200 x 6 x 10 cm
Purotouch®
Designed by
Orio Tonini

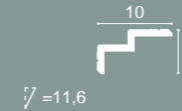

C391 STEPS
200 x 6 x 16 cm
Purotouch®
Designed by
Orio Tonini

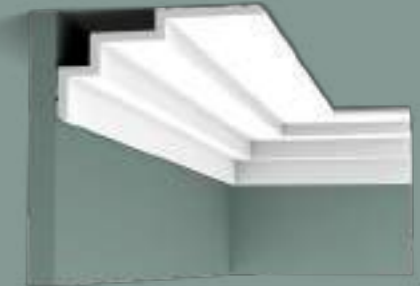
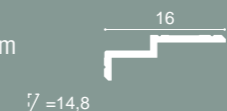

C392 STEPS
200 x 10 x 19 cm
Purotouch®
Designed by
Orio Tonini

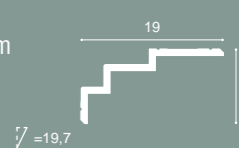

1 C393 STEPS
200 x 15 x 21 cm
Purotouch®
Designed by
Orio Tonini

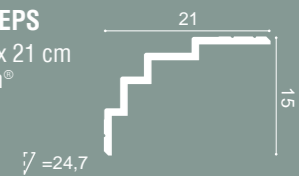

76

BORDER

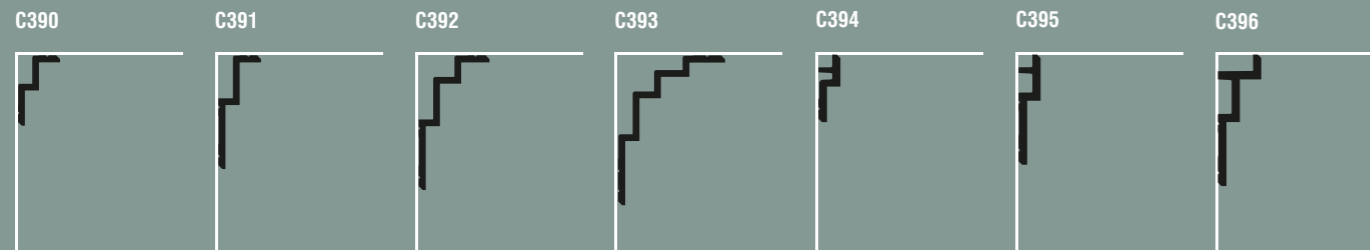

CURTAIN PROFILES | КАРНИЗЫ ДЛЯ ШТОР | PROFIL KARNISZOWE | سكة الستائر | PROFILS RIDEAU

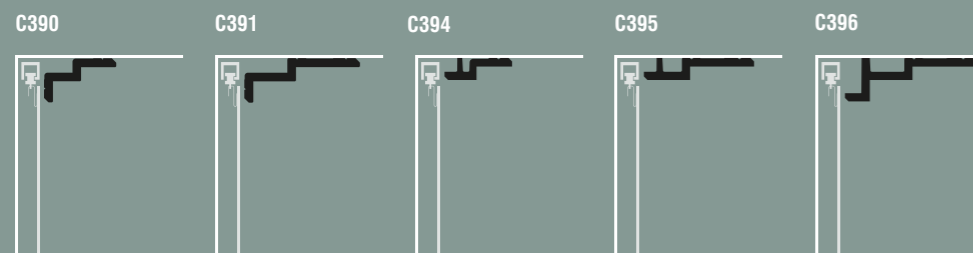

LED COVING | СКРЫТОЕ ОСВЕЩЕНИЕ | LISTWY OŚWIETLENIOWE | إضاءة غير مباشرة | ÉCLAIRAGE INDIRECT

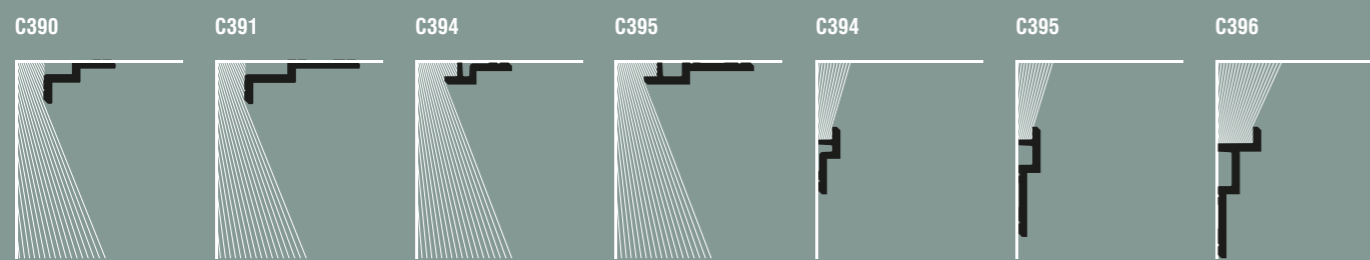

DOWNLIGHTER

UPLIGHTER

77



3 C360
200 x 2,1 x 6 cm
Purotouch®
Designed by
Jacques Vergracht



C356
200 x 2 x 10 cm
Purotouch®
Designed by
Jacques Vergracht



C355
200 x 3,5 x 11,1 cm
Purotouch®
Designed by
Jacques Vergracht



5 C353
200 x 3 x 16,5 cm
Purotouch®
Designed by
Jacques Vergracht



C354
200 x 4 x 21,5 cm
Purotouch®
Designed by
Jacques Vergracht



C602
200 x 5,3 x 5 cm
Purotouch®

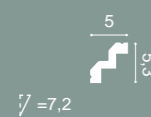

C400
200 x 6 x 10 cm
Purotouch®

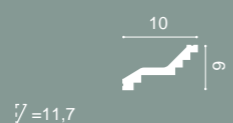

Curtain Profiles

КАРНИЗЫ ДЛЯ ШТОР / PROFILE KARNISZOWE
سكك الستائر / PROFILS RIDEAU



C394 STEPS CURTAIN PROFILE

200 x 3,1 x 9,5 cm
Purotouch®

Designed by
Orio Tonini

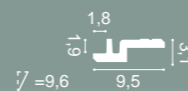

C395 STEPS CURTAIN PROFILE

200 x 3,1 x 15,5 cm
Purotouch®

Designed by
Orio Tonini



C390 STEPS CURTAIN PROFILE

200 x 6 x 10 cm
Purotouch®

Designed by
Orio Tonini



C391 STEPS CURTAIN PROFILE

200 x 6 x 16 cm
Purotouch®

Designed by
Orio Tonini



C396 STEPS CURTAIN PROFILE

200 x 6,1 x 18,5 cm
Purotouch®

Designed by
Orio Tonini



C991 CURTAIN PROFILE

200 x 11 x 14 cm
Purotouch®

Designed by
Ulf Moritz



C341 | C341F HERITAGE CURTAIN PROFILE

200 x 8,8 x 12,2 cm
Purotouch®

Designed by
Orio Tonini



C342 HERITAGE CURTAIN PROFILE

200 x 14 x 19 cm
Purotouch®

Designed by
Orio Tonini



C343 HERITAGE CURTAIN PROFILE

200 x 19 x 25 cm
Purotouch®

Designed by
Orio Tonini



C340 CURTAIN PROFILE

200 x 13,5 x 25,6 cm
Purotouch®

Designed by
Orio Tonini

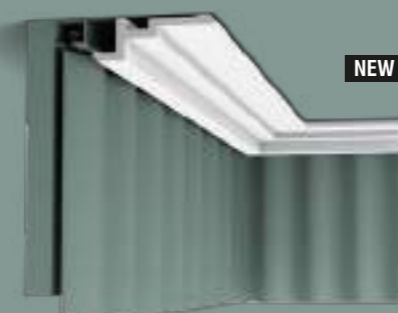

CX196 U-STEPS CURTAIN PROFILE

200 x 4 x 11,3 cm
Duropolymer®

Designed by
Orio Tonini



CX197 U-STEPS CURTAIN PROFILE

200 x 5 x 9,3 cm
Duropolymer®

Designed by
Orio Tonini





CX124 | CX124F
200 x 4,9 x 4,9 cm
Duropolymer®



CX100 | CX100F
200 x 6,9 x 7,1 cm
Duropolymer®



CX123 | CX123F
200 x 8 x 8 cm
Duropolymer®



CX111
200 x 2,6 x 1,5 cm
Duropolymer®

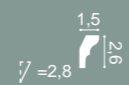

CX154
200 x 3 x 3 cm
Duropolymer®

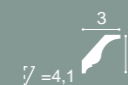

CX110 | CX110F
200 x 4,5 x 4,1 cm
Duropolymer®



5 CX127 | CX127F
200 x 9,4 x 9,4 cm
Duropolymer®



CX199 | CX199F
200 x 8 x 8 cm
Duropolymer®

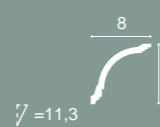

CX106 | CX106F
200 x 11,8 x 11,7 cm
Duropolymer®

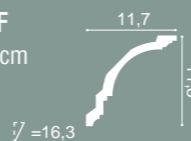

CX108
200 x 5,4 x 5,5 cm
Duropolymer®

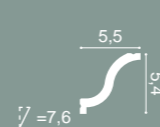

CX112
200 x 5,4 x 3,8 cm
Duropolymer®

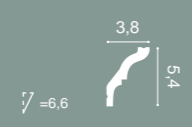

CX177
200 x 7 x 6 cm
Duropolymer®

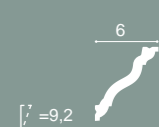

CX203
200 x 14,5 x 14,5 cm
Duropolymer®

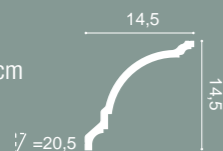

1. SX137 p.94 | 2. PX116 p.111 | 3. PX120 p.111 | 4. PX103 p.111 | 5. CX127 p.82



CX101
200 x 6,9 x 7,1 cm
Duropolymer®

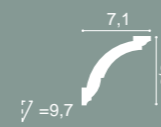

CX129
200 x 9,4 x 9,4 cm
Duropolymer®



CX128
200 x 9,4 x 9,4 cm
Duropolymer®

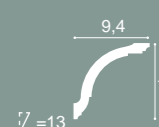

CX107
200 x 11,8 x 11,7 cm
Duropolymer®

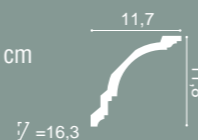



CX133
200 x 2 x 2 cm
Duopolymer®

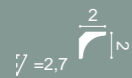

CX132 | CX132F
200 x 2 x 2 cm
Duopolymer®

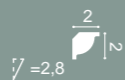

CX115
200 x 3 x 2,9 cm
Duopolymer®

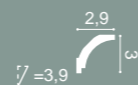

CX109 | CX109F
200 x 4,4 x 4,4 cm
Duopolymer®



CX126
200 x 8,7 x 8,7 cm
Duopolymer®

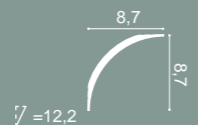

CX148
200 x 4,3 x 2,9 cm
Duopolymer®

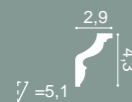

CX141
200 x 5,9 x 3,1 cm
Duopolymer®

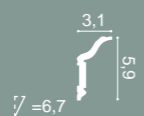

CX176
200 x 8 x 4 cm
Duopolymer®

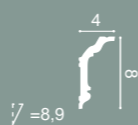

CX192
200 x 12 x 6 cm
Duopolymer®

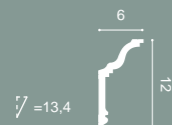

1. PX198 p.112 | 2. CX196 p.138 | 3. CX197 p.85



CX190 | CX190F U-PROFILE
200 x 3 x 2 cm
Duopolymer®



Designed by
Orio Tonini



NEW

CX196 U-STEPS
200 x 11,3 x 4 cm
Duopolymer®

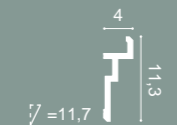

Designed by
Orio Tonini



NEW

CX197 U-STEPS
200 x 9,3 x 5 cm
Duopolymer®

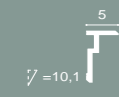

Designed by
Orio Tonini



NEW
NEW FLEX

PX198 | PX198F U-STEPS
200 x 2 x 8,3 cm
Duopolymer®



Designed by
Orio Tonini



NEW
NEW FLEX

PX198 | PX198F U-STEPS
200 x 2 x 8,3 cm
Duopolymer®



Designed by
Orio Tonini



SX194 | SX194F SQUARE
200 x 1 x 2 cm
Duropolymer®



PX164
200 x 3 x 2,4 cm
Duropolymer®

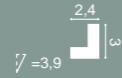

SX162 | SX162F SQUARE
200 x 1 x 4 cm
Duropolymer®



SX157 | SX157F SQUARE
200 x 1,3 x 6,6 cm
Duropolymer®



SX163 | SX163F SQUARE
200 x 1,3 x 10,1 cm
Duropolymer®



SX182 | SX182F CASCADE
200 x 1,3 x 5 cm
Duropolymer®



SX183 | SX183F CASCADE
200 x 1,3 x 7,5 cm
Duropolymer®



SX184 | SX184F CASCADE
200 x 1,3 x 11 cm
Duropolymer®



CX160
200 x 1,3 x 3,9 cm
Duropolymer®



CX161
200 x 1,3 x 6,9 cm
Duropolymer®



PB513
200 x 1,5 x 3,4 cm
Durofoam®



CB500
200 x 2,5 x 1,8 cm
Durofoam®

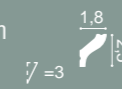

CB530
200 x 2,7 x 1,5 cm
Durofoam®

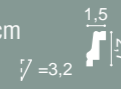

CB520
200 x 3,5 x 3,5 cm
Durofoam®



CB510
200 x 4 x 4 cm
Durofoam®

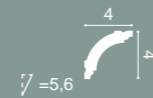

CB501
200 x 4,1 x 3,5 cm
Durofoam®



CB531
200 x 4,8 x 2,6 cm
Durofoam®



CB521
200 x 5 x 5 cm
Durofoam®



CB502
200 x 5,9 x 4,9 cm
Durofoam®



CB523
200 x 5,9 x 4,4 cm
Durofoam®

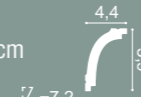

CB525
200 x 6,5 x 6 cm
Durofoam®

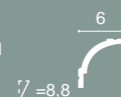

CB511
200 x 6,7 x 6,7 cm
Durofoam®



CB522
200 x 6,7 x 6,7 cm
Durofoam®



CB503
200 x 8,2 x 9,2 cm
Durofoam®



CB524
200 x 9 x 9 cm
Durofoam®



CB512
200 x 9,5 x 10 cm
Durofoam®



Skirting Boards

ПЛИНТУСЫ / LISTWY PRZYPODŁOGOWE
نعلات / PLINTHES



88

89

en

Modern or rustic. Large or small. Striking or discrete. Whatever your style, you'll find the skirting boards your home deserves in a design you'll love. Looking for a hassle-free solution? Our superior Duropolymer® quality is fully impact- and water-resistant.

ru

Современный или традиционный. Большой или маленький. Акцентный или незаметный. Каким бы ни был ваш стиль, вы найдете плинтус, достойный вашего дома, и дизайн, который вам понравится. Ищете решение без проблем? Наше превосходное качество Duropolymer® – это гарантированная ударпрочность и водостойкость.

pl

Nowoczesne lub rustykalne. Duże lub małe. Wyrziste lub dyskretne. U nas znajdziesz listwy przypodłogowe godne Twojego domu i dopasowane do Twojego indywidualnego stylu i upodobań. Szukasz bezproblemowego rozwiązania? Znakomita jakość naszego polimeru Duropolymer® oznacza całkowitą odporność na uderzenia i działanie wody.

ar

عصري أو ريفي. كبير أو صغير. صارخ أو هادئ. مهما كان نمطك المفضل، فستجد الوزرات التي تليق بمنزلك في تصميم سينال إعجابك. هل تبحث عن حل خال من المتاعب؟ تتميز قوالبنا Duropolymer® فائقة الجودة بأنها مقاومة تمامًا للصدمات والماء.

fr

Moderne ou rustique. Grand ou petit. Spectaculaire ou discret. Quel que soit votre style, vous trouverez la plinthe que votre maison mérite dans un design que vous adorerez. Vous cherchez une solution simple ? Notre Duropolymer® de qualité supérieure est entièrement résistant aux chocs et à l'eau.

DUROPOLYMER[®]

LOVES...

ru —

Duropolymer[®] любит краску, поставляется загрунтованным и легко покрывается качественной краской любого типа. Duropolymer[®] любит воду, но никогда не намокает, он водостойкий и сохраняет стабильность размеров. Duropolymer[®] любит выделяться благодаря острым краям и тонким деталям для создания высококачественного дизайна. Duropolymer[®] любит высокую нагрузку и устойчив к ударам и царапинам. Duropolymer[®] любит монтаж, он легкий и просто устанавливается с помощью клея Orac Deco[®] DecoFix. Duropolymer[®] любит экологию, производится с гарантированной переработкой, на 100 % пригоден для вторичной переработки и не содержит токсичных продуктов.

pl —

Duropolymer[®] uwielbia farbę, jest zagruntowany i łatwy do wykończenia za pomocą każdej farby wysokiej jakości. Duropolymer[®] uwielbia wodę, ale nigdy nie robi się mokry, jest wodoodporny i zachowuje swoje wymiary. Duropolymer[®] uwielbia wyróżniać się dzięki ostrym krawędziom i drobnym detalom, które tworzą strukturę wysokiej jakości. Duropolymer[®] uwielbia ciężką pracę i jest odporny na uderzenia, zderzenia i zarysowania. Duropolymer[®] uwielbia wieszanie, jest lekki i łatwy w montażu dzięki klejom Orac Deco[®] DecoFix. Duropolymer[®] uwielbia zrównoważony rozwój, jest produkowany z materiałów ze zintegrowanego recyklingu, w 100% nadaje się do recyklingu i nie zawiera toksycznych substancji.

ar —

تحب قوالب Duropolymer[®] الطلاء وتأتي مُجهزة ويسهل إضفاء اللمسة الأخيرة عليها باستخدام أي نوع طلاء عالي الجودة. تحب قوالب Duropolymer[®] الماء ولكنها لا تبتل أبدًا، فهي مقاومة للماء وثابتة الأبعاد. تحب قوالب Duropolymer[®] أن تتميز بحوافها الحادة وتفصيلها المتقنة التي تمنحها تصميمًا عالي الدقة. تحب قوالب Duropolymer[®] العمل الشاق وهي مقاومة للددق والصدمات والخدش. تحب قوالب Duropolymer[®] أن تلتصق ببعضها البعض، فهي خفيفة الوزن وسهلة التركيب باستخدام لاصق DecoFix من Orac Decor[®]. تحب قوالب Duropolymer[®] الاستدامة، فهي منتجة باستخدام عملية إعادة التدوير المتكاملة وهي قابلة لإعادة التدوير بنسبة 100% ولا تحتوي على أي منتجات سامة.

fr —

Duropolymer[®] aime la peinture, est livré avec un apprêt et est facile à finir avec n'importe quel type de peinture de qualité. Duropolymer[®] aime l'eau mais ne devient jamais humide, résiste à l'eau et est dimensionnellement stable. Duropolymer[®] aime se démarquer par ses bords tranchants et ses détails raffinés pour un design haute définition. Duropolymer[®] aime travailler, résiste aux chocs, aux rayures et aux impacts. Duropolymer[®] aime bien se tenir, est léger et facile à installer avec les colles Orac Deco[®] DecoFix. Duropolymer[®] aime la durabilité, est fabriqué avec un recyclage intégré, est 100 % recyclable et ne contient aucun produit toxique.



PAINT

primed and easy to finish with any type of quality paint

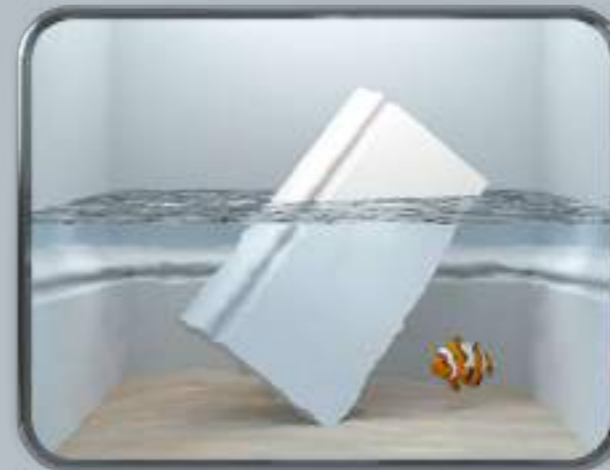

WATER

but never gets wet; water resistant and dimensionally stable



TO STAND OUT

sharp edges and fine details for high-definition design



HARD WORK

knock-, impact- and scratch-resistant



TO HANG AROUND

light -weight and easy to install with Orac Deco[®] DecoFix glues



SUSTAINABILITY

produced with 40% renewable energy, 100% recyclable, contains no toxic products

3 essential Skirting Board families

CHOOSE YOUR STYLE. GET CREATIVE.

ru

3 семейства плинтусов.
Выберите свой стиль.
Вдохновляйтесь и создавайте.

pl

3 podstawowe rodziny listew
przyścielowych.
Wybierz swój styl. Bądź
kreatywny.

ar

ثلاث عائلات أساسية التفاف
اختراروا نمطكم. كونوا مبدعين.

fr

3 essentielles familles
de plinthes.
Choisissez votre style. Faites
preuve de créativité.



1. SX118 p.93 | 2. P4020 p.106 | 3. P8030 p.106 | 4. C339 p.72

SQUARE



CASCADE



CONTOUR



SMALL



SX162 | SX162F
SQUARE
200 x 4 x 1 cm
Duropolymer®



SX182 | SX182F
CASCADE
200 x 5 x 1,3 cm
Duropolymer®

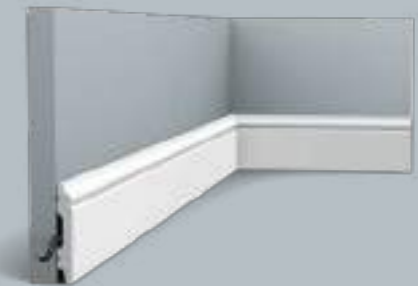

SX165 | SX165F
CONTOUR
200 x 6,9 x 1,1 cm
Duropolymer®



MEDIUM

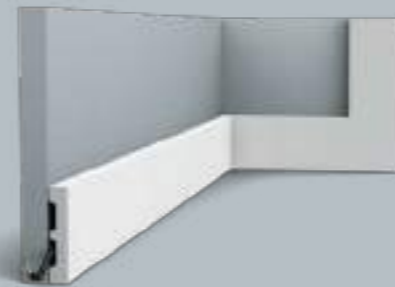

SX157 | SX157F | SX157-RAL9003
SQUARE
200 x 6,6 x 1,3 cm
Duropolymer®

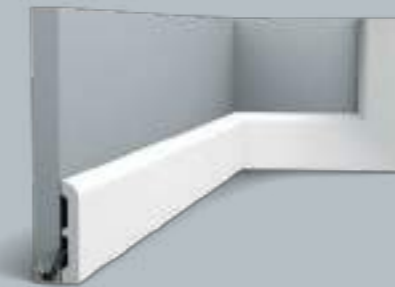

SX183 | SX183F | SX183-RAL9003
CASCADE
200 x 7,5 x 1,3 cm
Duropolymer®



SX173 | SX173F | SX173-RAL9003
CONTOUR
200 x 10 x 1,6 cm
Duropolymer®



BIG

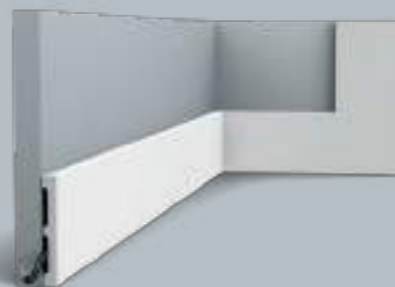

SX163 | SX163F | SX163-RAL9003
SQUARE
200 x 10,1 x 1,3 cm
Duropolymer®



SX184 | SX184F | SX184-RAL9003
CASCADE
200 x 11 x 1,3 cm
Duropolymer®



SX118 | SX118F | SX118-RAL9003
CONTOUR
200 x 13,9 x 1,8 cm
Duropolymer®



COVER

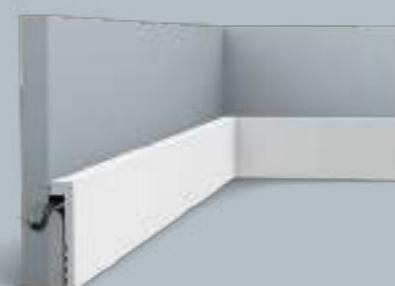

SX171
SQUARE
200 x 10 x 2,2 cm
Duropolymer®



SX185
CASCADE
200 x 12 x 2,5 cm
Duropolymer®

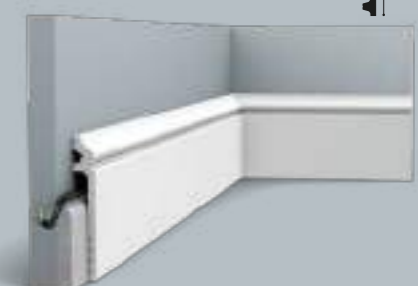

SX186
CONTOUR
200 x 13,8 x 2,2 cm
Duropolymer®





1. SX193 p.94 | 2. W120 p.126



SX122
200 x 7,9 x 2,2 cm
Duropolymer®



SX137 | SX137F
200 x 10 x 1,5 cm
Duropolymer®

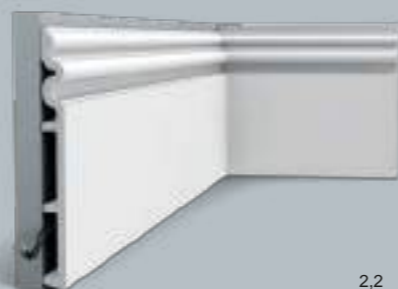

1 SX193 AUTOIRE
200 x 25 x 2,2 cm
Duropolymer®
Designed by
Orio Tonini

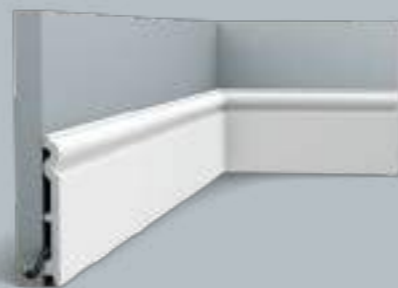

SX138 | SX138F
200 x 13,8 x 1,5 cm
Duropolymer®



SX104 | SX104F
200 x 14,8 x 1,7 cm
Duropolymer®

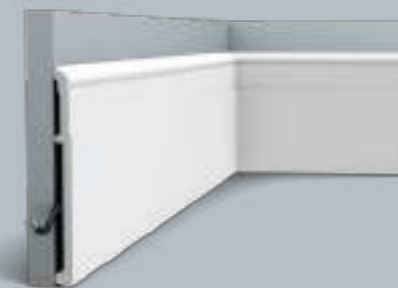

SX156 HIGH HEELS
200 x 20,2 x 1,6 cm
Duropolymer®
Designed by
Xavier Donck



3 SX191 HIGH RISE
200 x 21 x 2,1 cm
Duropolymer®



3. SX191 p.95 | 4. PX175 p.111 | 5. DX174-2300 p.110 | 6. DX170-2300 p.150



1. SX195 p.96 | 2. P8030 p.106 | 3. W113 p.122



SX187 | SX187F HIGH LINE
200 x 7,5 x 1,2 cm
Duropolymer®
Designed by
Pierre Daems



4 SX180 | SX180F HIGH LINE
200 x 12 x 1,6 cm
Duropolymer®
Designed by
Pierre Daems



SX181 HIGH LINE
200 x 20 x 2,2 cm
Duropolymer®
Designed by
Pierre Daems



4. SX180F p.97



1 SX195 | SX195F HAMBURG
200 x 8 x 1,9 cm
Duropolymer®



SX105 | SX105F
200 x 10,8 x 1,3 cm
Duropolymer®



SX155 | SX155F
200 x 10,8 x 2,5 cm
Duropolymer®





SX194 | SX194F SQUARE
200 x 2 x 1 cm
Duropolymer®



1 CX190 | CX190F U-PROFILE
200 x 3 x 2 cm
Duropolymer®
Designed by
Orio Tonini



PX198 | PX198F U-STEPS
200 x 8,3 x 2 cm
Duropolymer®
Designed by
Orio Tonini



NEW
NEW FLEX



PX198 | PX198F U-STEPS
200 x 8,3 x 2 cm
Duropolymer®
Designed by
Orio Tonini



NEW
NEW FLEX



CX132 | CX132F
200 x 2 x 2 cm
Duropolymer®



CX133
200 x 2 x 2 cm
Duropolymer®



SX159
200 x 6 x 1,2 cm
Duropolymer®



SX125
200 x 6,9 x 1,4 cm
Duropolymer®

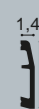

SX172 | SX172F
200 x 8,5 x 1,4 cm
Duropolymer®



SX179 DIAGONAL
200 x 9,7 x 2,9 cm
Duropolymer®
Designed by
Orio Tonini

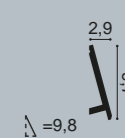

Cover Skirting Boards

НАКЛАДНОЙ ПЛИНТУС / LISTWA PRZYKRYWAJĄCA
نعلة تغطية / SURPLINTHE



SX171 SQUARE
200 x 10 x 2,2 cm
Duropolymer[®]

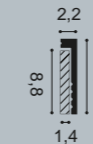

SX185 CASCADE
200 x 12 x 2,5 cm
Duropolymer[®]

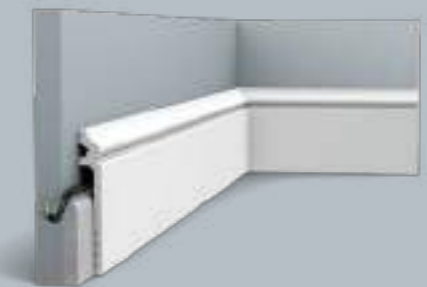

SX186 CONTOUR
200 x 13,8 x 2,2 cm
Duropolymer[®]

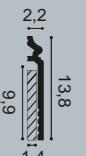

PAINTABLE
Легко окрашиваются
Można malować
يمكن طلاؤها
Peut être peint



WATER RESISTANT
Не боятся воды
Wodoodporne
مقاومة للماء
Résistant à l'eau



IDEAL FOR RENOVATIONS
Идеален для ремонта
Idealne do renowacji
مثالية لأعمال الترميم
Idéal pour des rénovations



Multifunctional

МНОГОФУНКЦИОНАЛЬНЫЕ / WIELOFUNKCYJNE

متعددة الإستعمالات / MULTIFONCTIONNEL



SX163 | SX163F SQUARE
200 x 10,1 x 1,3 cm
Duropolymer®



SX168 SQUARE
200 x 15,1 x 1,4 cm
Duropolymer®

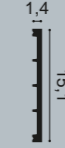

SX182 | SX182F CASCADE
200 x 5 x 1,3 cm
Duropolymer®

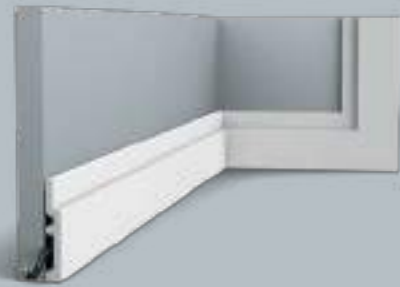

SX187 | SX187F HIGH LINE
200 x 7,5 x 1,2 cm
Duropolymer®



SX180 | SX180F HIGH LINE
200 x 12 x 1,6 cm
Duropolymer®

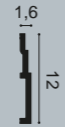

SX181 HIGH LINE
200 x 20 x 2,2 cm
Duropolymer®

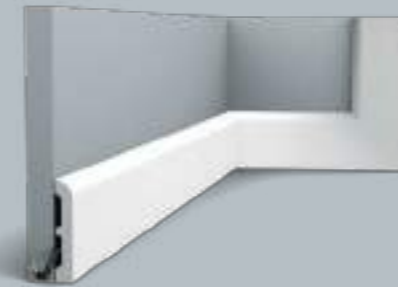

SX183 | SX183F CASCADE
200 x 7,5 x 1,3 cm
Duropolymer®



SX184 | SX184F CASCADE
200 x 11 x 1,3 cm
Duropolymer®



SX159
200 x 6 x 1,2 cm
Duropolymer®



SX194 | SX194F SQUARE
200 x 2 x 1 cm
Duropolymer®



CX190 | CX190F U-PROFILE
200 x 3 x 2 cm
Duropolymer®



PX198 | PX198F U-STEPS
200 x 8,3 x 2 cm
Duropolymer®



PX198 | PX198F U-STEPS
200 x 8,3 x 2 cm
Duropolymer®

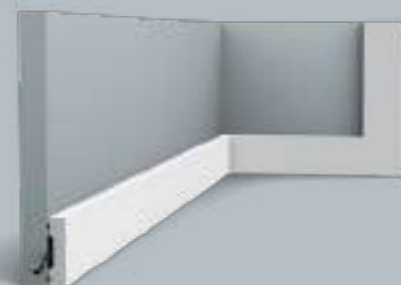

SX162 | SX162F SQUARE
200 x 4 x 1 cm
Duropolymer®



SX157 | SX157F SQUARE
200 x 6,6 x 1,3 cm
Duropolymer®



Designed by
Orio Tonini



en — Profiles with endless possibilities. Each element can be used as a panel moulding, cornice moulding, door surround or as skirting board.

ru — Бесконечное множество вариантов использования. Один и тот же профиль можно использовать как молдинг, карниз, дверное обрамление или плинтус.

pl — Profile z nieskończonymi możliwościami. Jeden i ten sam element może być użyty jako profil ścienny, listwa przysufitowa, obramowanie drzwi czy listwa przypodłogowa.

ar — قوالب ذات إستعمالات غير محدودة. يمكن استعمال القالب نفسه ككورنيش، إطار للأبواب، قالب للجدران ونعلة.

fr — Des profils avec des possibilités illimitées. Un même profil peut être utilisé comme décoration murale: comme encadrement de porte, corniche, cimaise ou comme plinthe.



Panel Mouldings

МОЛДИНГИ / PROFILE ŚCIENNE

قوالب للجدران / CIMAISES



en —

Make your walls come to life by "wallscaping" them with panel mouldings. Integrating indirect lighting, visually changing ceiling height, adding character and bringing symmetry, our panel mouldings are the ideal addition to your home.

ru —

Оживите свои стены, украсив их стенограммой с панельными молдингами. Наши молдинги, сочетающие скрытое освещение, визуальное изменение высоты потолка, придание индивидуальности и симметрии, станут идеальным дополнением к интерьеру вашего дома.

pl —

Dzięki profilom ściennym panelowym „wyrzeźbisz” swoje ściany i ożywisz je. Nasze profile ścienne panelowe to idealny dodatek do Twojego domu – można w nich zamontować oświetlenie pośrednie, zmieniają też wizualnie wysokość sufitu, nadają charakter i wprowadzają symetrię do Twojego domu.

ar —

دع جدرانك تنبض بالحياة من خلال "تنسيق رسوم الجدران" باستخدام القوالب اللوحية. سواء كنت ترغب في إدماج إضاءة غير مباشرة أو تغيير ارتفاع السقف باستخدام التأثيرات البصرية أو إضفاء لمسة شخصية أو تحقيق التناسق، فستجد أن قوالبنا اللوحية هي الإضافة المثالية لمنزلك.

fr —

Donnez vie à vos murs en les « sculptant » avec des cimaises. Intégrant un éclairage indirect, changeant visuellement la hauteur du plafond, ajoutant du caractère et apportant une symétrie, nos cimaises constituent le complément idéal à votre maison.



2 P8030 | P8030F
200 x 4,1 x 1,7 cm
Purotouch®

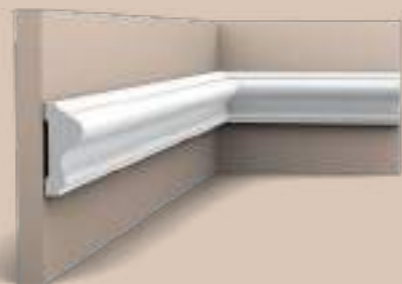

P8020 | P8020F
200 x 6 x 2,6 cm
Purotouch®



P8050 | P8050F
200 x 12 x 3 cm
Purotouch®



P1020
200 x 4,9 x 2,4 cm
Purotouch®



P3020 | P3020F
200 x 6,1 x 3,2 cm
Purotouch®



P4020 | P4020F
200 x 5 x 2,9 cm
Purotouch®

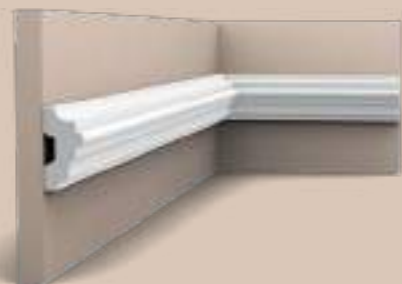

P9040
200 x 5 x 2,5 cm
Purotouch®



P9010 | P9010F
200 x 9,1 x 3 cm
Purotouch®

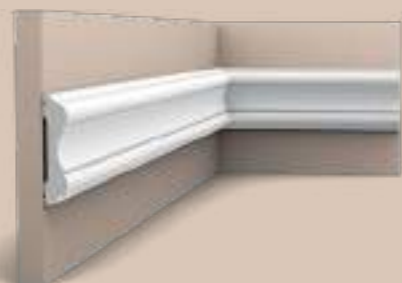

P8040 | P8040F
200 x 10,1 x 2,2 cm
Purotouch®



P4025 | P4025F AUTOIRE
200 x 8,3 x 3,4 cm
Purotouch®
Designed by
Orio Tonini



P9020
200 x 9,6 x 2,1 cm
Purotouch®



P6020
200 x 6,4 x 2,8 cm
Purotouch®



P7030
200 x 8,5 x 1,7 cm
Purotouch®



P7020
200 x 11,1 x 1,9 cm
Purotouch®



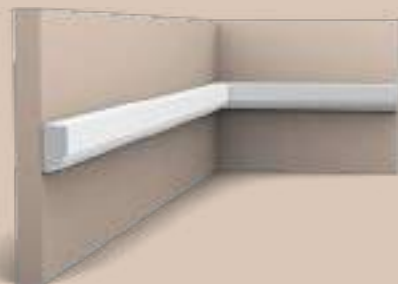

P9050 | P9050F
200 x 2,5 x 1,3 cm
Purotouch®



P5021 | P5021F
200 x 3,1 x 0,9 cm
Purotouch®

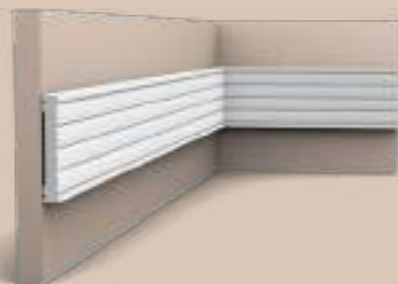

P5020
200 x 9,1 x 1,3 cm
Purotouch®

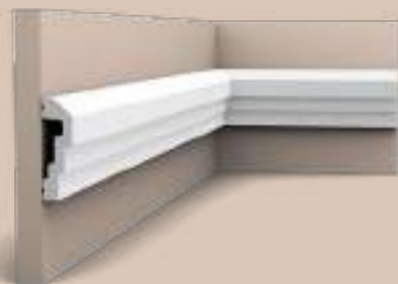

P7070 | P7070F
200 x 7,4 x 2,2 cm
Purotouch®



P9900 | P9900F
200 x 8 x 1 cm
Purotouch®

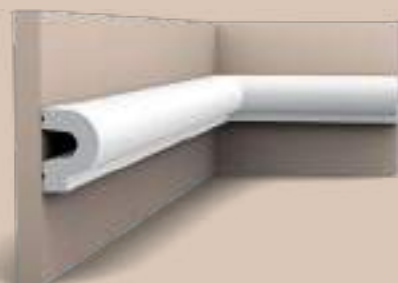

P8060
200 x 5 x 3,5 cm
Purotouch®

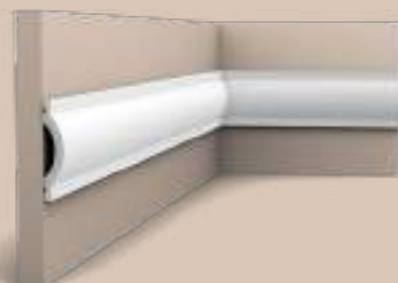

P9901
200 x 7 x 1,4 cm
Purotouch®

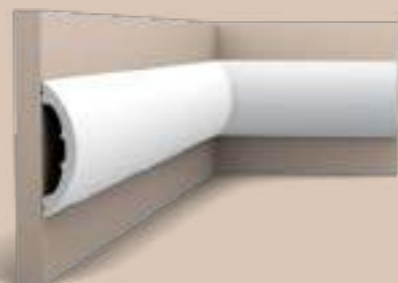

P3070 RADIUS
200 x 12,5 x 3,2 cm
Purotouch®
Designed by
Ulf Moritz

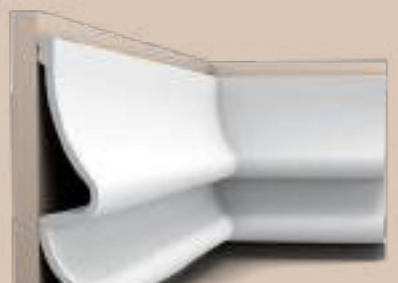

P3071 GOLF
200 x 37,2 x 7,6 cm
Purotouch®
Designed by
Ulf Moritz



1. P3071 p.108



2 DX174-2300 | DX174F
230 x 6 x 2,2 cm (DX174-2300)
Duropolymer®
200 x 6 x 2,2 cm (DX174F)



DX170-2300
230 x 11,9 x 3,2 cm
Duropolymer®

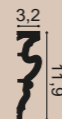

DX119-2300
230 x 9,2 x 2,2 cm
Duropolymer®



DX121-2300
230 x 9,4 x 2,3 cm
Duropolymer®

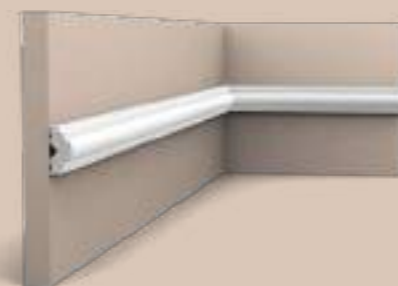

PX103 | PX103F
200 x 2,5 x 1,2 cm
Duropolymer®



PX120 | PX120F
200 x 4 x 1,9 cm
Duropolymer®

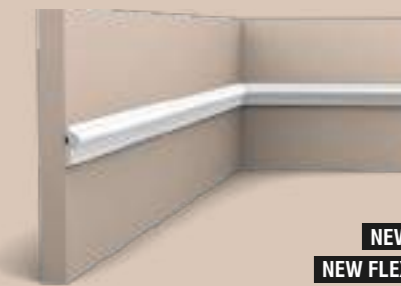

PX201 | PX201F
200 x 2,5 x 0,8 cm
Duropolymer®



NEW
NEW FLEX



PX175 | PX175F
200 x 5 x 1,7 cm
Duropolymer®

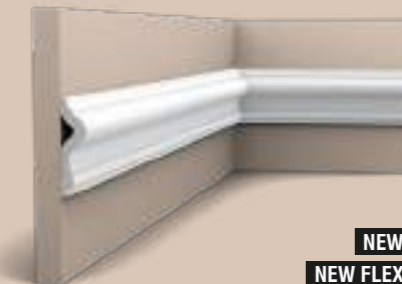

PX202 | PX202F
200 x 7,5 x 2 cm
Duropolymer®



NEW
NEW FLEX



PX116
200 x 3,1 x 1 cm
Duropolymer®



PX117
200 x 3,5 x 1,5 cm
Duropolymer®



PX113
200 x 6 x 2,7 cm
Duropolymer®



PX144 | PX144F
200 x 4,7 x 0,8 cm
Duropolymer®



PX102
200 x 7,9 x 1,6 cm
Duropolymer®



SX159
200 x 6 x 1,2 cm
Duropolymer®



1. SX191 p.95 | 2. DX174-2300 p.110 | 3. W130 p.120

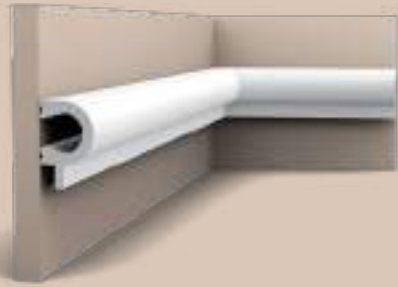

PX169 A
200 x 5,5 x 3,4 cm
Duropolymer[®]

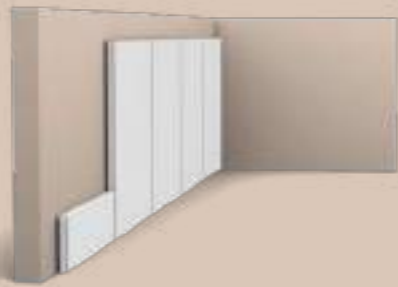

PX147 B
200 x 16,9 x 0,9 cm
Duropolymer[®]

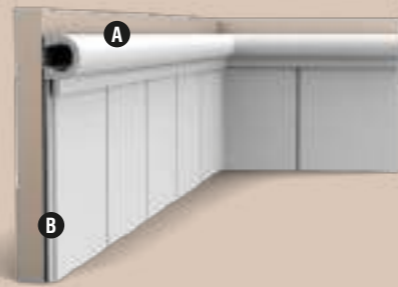

PX169 + PX147

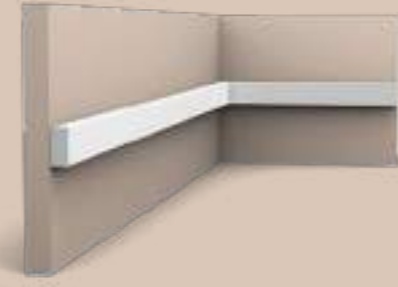

SX194 | SX194F SQUARE
200 x 2 x 1 cm
Duropolymer[®]



SX162 | SX162F SQUARE
200 x 4 x 1 cm
Duropolymer[®]

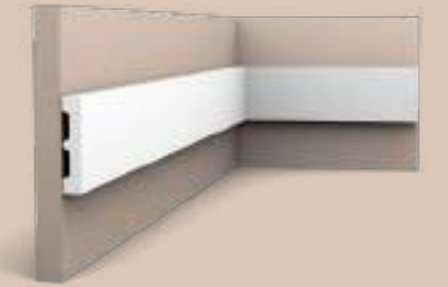

SX157 | SX157F SQUARE
200 x 6,6 x 1,3 cm
Duropolymer[®]

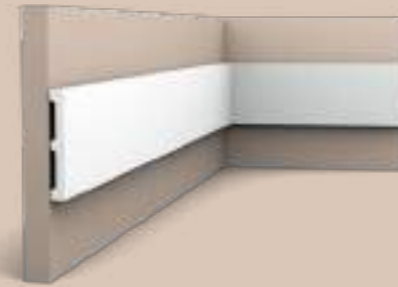

SX163 | SX163F SQUARE
200 x 10,1 x 1,3 cm
Duropolymer[®]

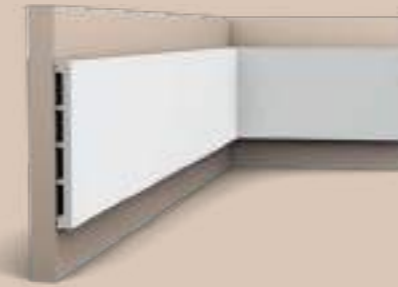

SX168 SQUARE
200 x 15,1 x 1,4 cm
Duropolymer[®]

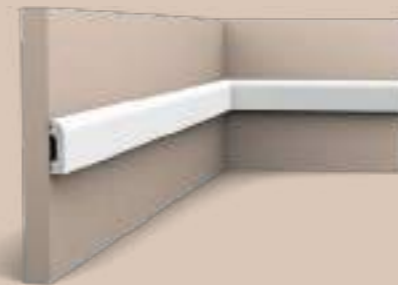

SX182 | SX182F CASCADE
200 x 5 x 1,3 cm
Duropolymer[®]



SX183 | SX183F CASCADE
200 x 7,5 x 1,3 cm
Duropolymer[®]

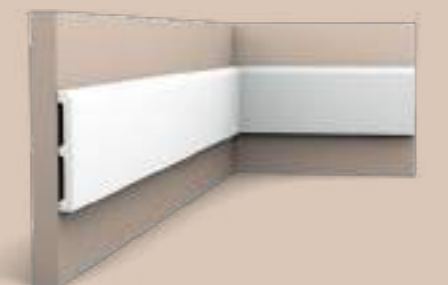

SX184 | SX184F CASCADE
200 x 11 x 1,3 cm
Duropolymer[®]

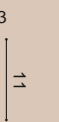

1. P8020 p.106 | 2. P4020 p.106



CX190 | CX190F U-PROFILE
200 x 3 x 2 cm
Duropolymer[®]
Designed by
Orio Tonini

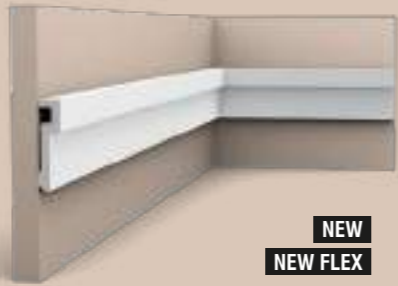

PX198 | PX198F U-STEPS
200 x 8,3 x 2 cm
Duropolymer[®]
Designed by
Orio Tonini

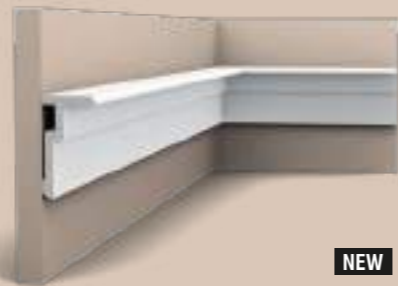

CX197 U-STEPS
200 x 9,3 x 5 cm
Duropolymer[®]
Designed by
Orio Tonini

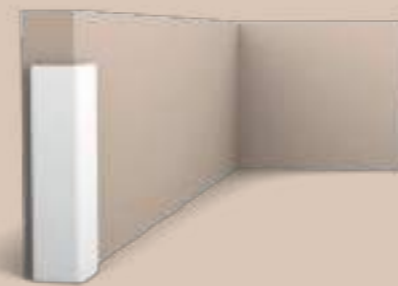

CX134
200 x 3 x 3 cm
Duropolymer[®]





1. PX120 p.111 | 2. SX156 p.95 | 3. P3020A p.115 | 4. P3020 p.107



P5020B + P5020
9 x 9 x 1,3 cm
Purotouch®



P101A + P1020
24,5 x 24,5 x 2,4 cm
Purotouch®



P801C + P8020
19,8 x 11 x 2,6 cm
Purotouch®



P4020A + P4020
16,4 x 9,1 x 2,9 cm
Purotouch®



3 P3020A + P3020
42,5 x 42,5 x 4 cm
Purotouch®



P20 + P101A
Ø 6,1 - 0,8 cm
Duropolymer®



PX103A + PX103
19 x 3,5 x 1,5 cm
Duropolymer®



P8030D + P8030
13,2 x 13,2 x 1,7 cm
Duropolymer®



P8030C + P8030
19 x 8,6 x 1,7 cm
Duropolymer®



PX120A + PX120
19 x 8,8 x 2 cm
Duropolymer®

3D Wall Covering

3D СТЕНОВЫЕ ПОКРЫТИЯ / PANELE 3D
إضاءة غير مباشرة / REVÊTEMENTS MURAUX 3D



en

Modern and contemporary. Bold and outspoken. Textured and fascinating. What inspires you and your walls? Create an immediate wow effect with our 3D Wall Covering. From large 3D panels to classic shapes, we have a range of eye-catching styles for every home.

ru

Модернистские и современные. Смелые и выразительные. Текстурированные и очаровательные. Что вдохновляет вас и ваши стены? Создайте мгновенный вау-эффект с помощью наших 3D-покрытий для стен. От больших 3D-панелей до классических форм – у нас есть широкий выбор эффектных стилей для любого дома.

pl

Współczesne i nowoczesne. Odważne i wyraziste. Teksturowane i fascynujące. Co jest inspirujące dla Ciebie i Twoich ścian? Osiągnij natychmiastowy niezwykle efekt dzięki naszej sztukaterii 3D. Od dużych paneli 3D po klasyczne kształty – oferujemy szeroki wybór produktów w atrakcyjnych stylach dla każdego domu.

ar

حديثة ومعاصرة. جريئة وبارزة. ذات أسطح غير ملساء ورائعة التصميم. ما الذي يلهمك ويلهم تصاميم جدرانك؟ احصل على تأثير فوري مبهز باستخدام ورق الحائط ثلاثي الأبعاد الخاص بنا. لدينا مجموعة من التصاميم الجذابة التي تناسب جميع المنازل، من اللوحات الكبيرة ثلاثية الأبعاد إلى الأشكال الكلاسيكية.

fr

Modernes et contemporains. Audacieux et prononcés. Texturés et fascinants. Qu'est-ce qui vous inspire, vous et vos murs ? Créez un effet éblouissant immédiat avec notre revêtement mural 3D. Des grands panneaux 3D aux formes classiques, nous avons une gamme de styles attrayants pour chaque maison.



W108 | W108F ZIGZAG

200 x 25 x 1,8 cm
Purotouch®
Designed by
Orio Tonini



W108 ZIGZAG + 2x CX190



W109 | W109F VALLEY

200 x 25 x 1,3 cm
Purotouch®
Designed by
Orio Tonini



W109 VALLEY + 2x CX190



1 W110 | W110F HILL

200 x 25 x 1,6 cm
Purotouch®
Designed by
Orio Tonini



W110 HILL + 2x CX190



3 W111 | W111F BAR

200 x 25 x 2 cm
Purotouch®
Designed by
Orio Tonini



W111 + CX190 + PX198



1. W110 p.118 | 2. CX190F p.138



2 W130 CHEVRON
200 x 40 x 2 cm
Purotouch®

W130 + 2x CX190

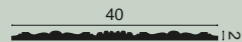

120



1. CX190 p.98 | 2. W130 p.120



5 W114 | W114F VALLEY XL

200 x 25 x 1,5 cm
Purotouch®
Designed by
Orio Tonini



W114 + 2x CX190



6 W116 | W116F BAR XL

200 x 25 x 2 cm
Purotouch®
Designed by
Orio Tonini

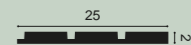

W111 + CX190 + PX198

3. SX191 p.95 | 4. SX194 p.98 | 5. W114 p.121 | 6. W116 p.121 | 7. W111 p.118

121



4 W112 RIDGE
200 x 25 x 1,9 cm
Purotouch®
Designed by
Orio Tonini

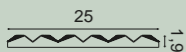

W112 + 2x CX190



2 W113 COBBLE
200 x 25 x 2,18 cm
Purotouch®
Designed by
Orio Tonini



W113 + 2x CX190

122



2

1

1. SX155 p.96 | 2. W113 p.122



4

3

3. SX171 p.101 | 4. W112 p.122

123

Positive Thermal & Acoustic Effects

ОТЛИЧНЫЙ ТЕПЛОИЗОЛЯЦИОННЫЙ И АКУСТИЧЕСКИЙ ЭФФЕКТ

POZYTYWNE EFEKTY TERMICZNE I AKUSTYCZNE

التأثيرات الحرارية والصوتية الإيجابية

EFFETS THERMIQUES ET ACOUSTIQUES POSITIFS

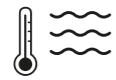

THERMAL INSULATION

Термоизоляция | Izolacja cieplna
العزل الحراري | Isolation thermique

$\lambda = 0,029 \text{ W/mK} - R = 0,55 \text{ m}^2\text{K/W}$

Equals effect of insulation board
of the same thickness.

Равный эффект изоляции плиты одинаковой толщины
Równoważny efekt płyty izolacyjnej o tej samej grubości.

يساوي تأثير لوح العزل بنفس المساحة

Avec le même effet que des panneaux isolants
de la même épaisseur.



ACOUSTIC ABSORPTION

Звукопоглощение | Absorpcja akustyczna
امتصاص الصوت | Absorption acoustique

CLASS E

Absorbs up to 25% of a conversation.

Поглощает до 25% разговоров.
Absorbuje do 25% rozmowy.

يمتص ما يصل إلى 25% من المحادثة

Absorbe jusqu'à 25% des conversations.



Flex Panels

Our wall panels ZIGZAG, VALLEY (XL), HILL (XL) and BAR (XL) are now also available in a flexible version.

Наши стеновые панели ZIGZAG, VALLEY (XL), HILL (XL) и BAR теперь также доступны в гибкой версии.

Nasze panele ściienne ZIGZAG, VALLEY (XL), HILL (XL) i BAR są teraz dostępne również w wersji elastycznej.

لوحات الحائط ZIGZAG (XL) VALLEY (XL) و HILL متوفرة الآن في إصدار مرن.

Nos panneaux muraux ZIGZAG, VALLEY (XL), HILL (XL) et BAR sont désormais également disponibles en version flexible.



1 W108 | W108F ZIGZAG

200 x 25 x 1,8 cm
Purotouch®

Designed by
Orio Tonini

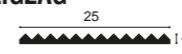

2 W109 | W109F VALLEY

200 x 25 x 1,3 cm
Purotouch®

Designed by
Orio Tonini

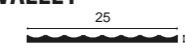

3 W110 | W110F HILL

200 x 25 x 1,6 cm
Purotouch®

Designed by
Orio Tonini



W111 | W111F BAR

200 x 25 x 2 cm
Purotouch®

Designed by
Orio Tonini



W114 | W114F VALLEY XL

200 x 25 x 1,5 cm
Purotouch®

Designed by
Orio Tonini



W116 | W116F BAR XL

200 x 25 x 2 cm
Purotouch®

Designed by
Orio Tonini

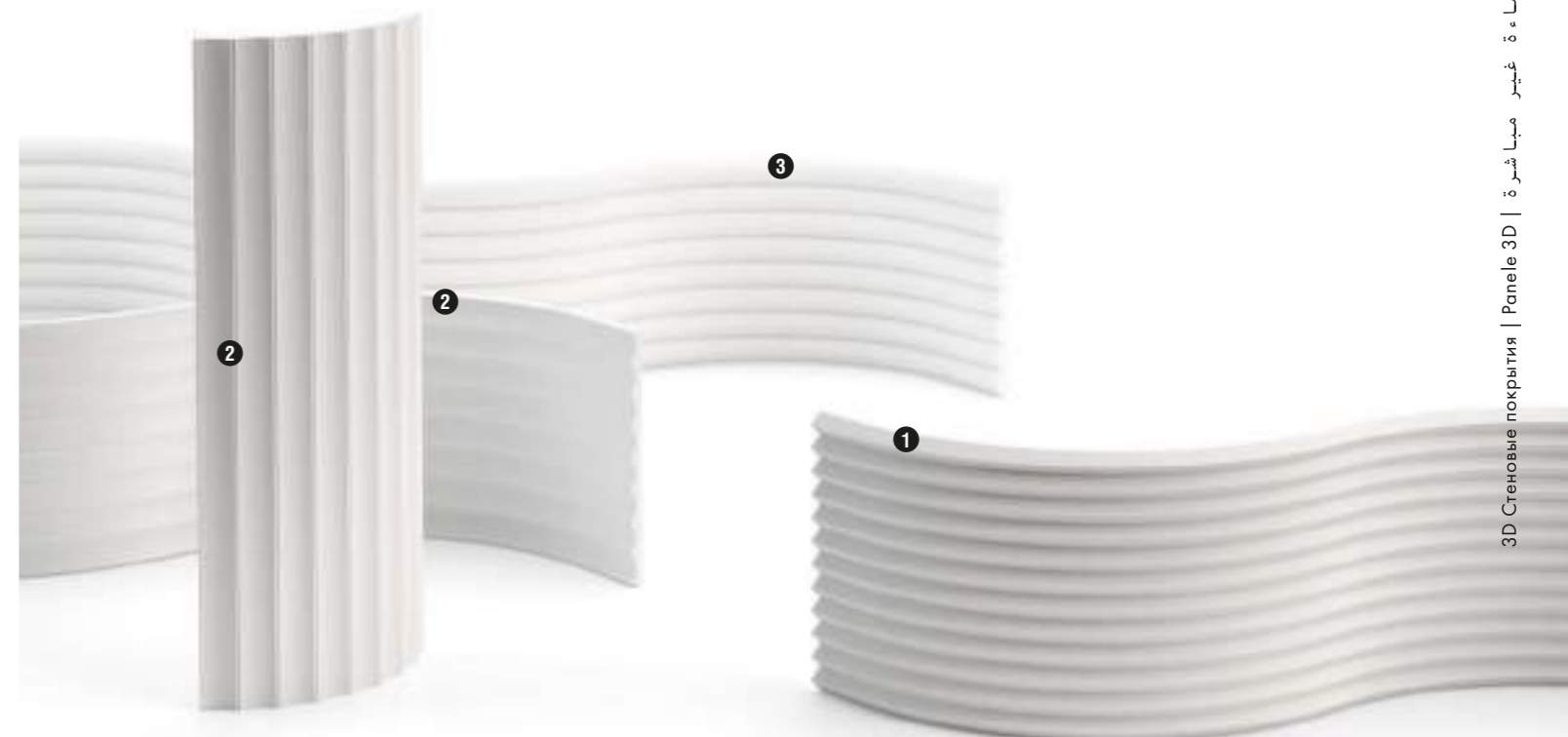

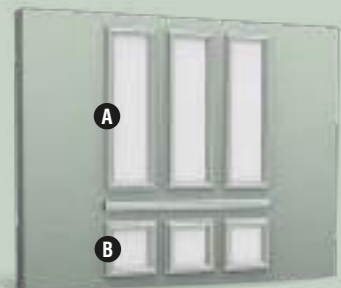

W120 + P4025 + W121
Purotouch®
Designed by
Orio Tonini



6 W120 AUTOIRE A
50 x 150 x 3,2 cm
Purotouch®
Designed by
Orio Tonini

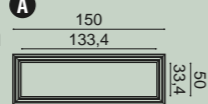

2 W121 AUTOIRE B
50 x 50 x 3,2 cm
Purotouch®
Designed by
Orio Tonini

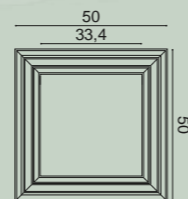

4 W122 AUTOIRE C
33,3 x 33,3 x 2,6 cm
Purotouch®
Designed by
Orio Tonini

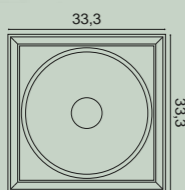

W120 + 4*W122
Purotouch®
Designed by
Orio Tonini

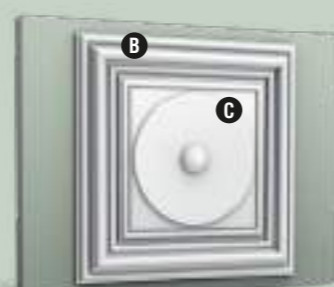

W121 + W122
Purotouch®
Designed by
Orio Tonini



5 W123 AUTOIRE D
33,3 x 33,3 x 3,5 cm
Purotouch®
Designed by
Orio Tonini

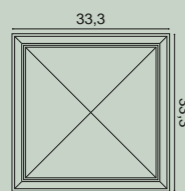

W120 + 4*W123
Purotouch®
Designed by
Orio Tonini

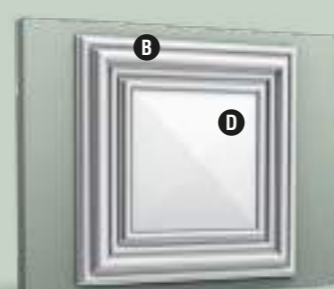

W121 + W123
Purotouch®
Designed by
Orio Tonini



1. SX138 p.94 | 2. W121 p.126 | 3. P4020 p.106 | 4. W122 p.126 | 5. W123 p.126 | 6. W120 p.126 | 7. C324 p.132

CEILING ORNAMENTS / ПОТОЛОЧНЫЕ ПЛИТКИ / PANELE SUFITOWE
زينة للسقوف / DÉCORATION DE PLAFONDS



W100 ROMBUS
25,8 x 15 x 2,9 cm
Purotouch®

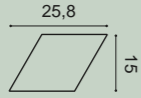

W101 TRAPEZIUM
34,5 x 15 x 2,9 cm
Purotouch®

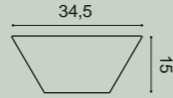

W105 ROMBUS
30 x 34,6 x 3 cm
Purotouch®

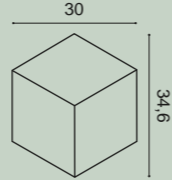

W102 CUBI
33,3 x 33,3 x 2,5 cm
Purotouch®

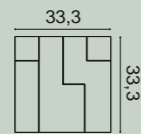

W103 CUBI
33,3 x 33,3 x 2,5 cm
Purotouch®

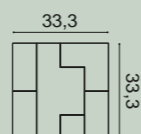

1 W106 ENVELOP
33,3 x 33,3 x 2,9 cm
Purotouch®
Designed by
Orio Tonini

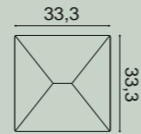

2 W107 CIRCLE
33,3 x 33,3 x 2,9 cm
Purotouch®
Designed by
Orio Tonini

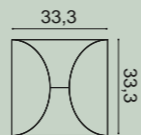

3 F30
59,5 x 59,5 x 4,3 cm
Purotouch®

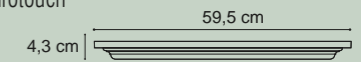

1. W106 p.128 | 2. W107 p.128



3. F30 p.129

Led Coving

СКРЫТОЕ ОСВЕЩЕНИЕ / LISTWY OŚWIETLENIOWE

إضاءة غير مباشرة / ÉCLAIRAGE INDIRECT



en

Enhance the architecture of your room and add atmosphere with led coving solutions that match your style. From sleek to organic, uplights to downlights, linear to diffuse, our range lets you play with shadow and light to make your room look larger or cosier.

ru

Расширьте архитектуру помещения и создайте атмосферу со скрытым освещением под ваш стиль. Элегантных до естественных форм, от верхнего до нижнего света, от линейных до рассеивающих – наш ассортимент дает вам возможность играть с тенями и светом, чтобы сделать интерьер вашей комнаты более просторным или уютным.

pl

Popraw architekturę swojego wnętrza i zbuduj nastrój dzięki dopasowanym stylowo rozwiązaniom w zakresie oświetlenia pośredniego. Oświetlenie eleganckie lub organiczne, skierowane ku górze lub ku dołowi, skupione lub rozproszone – nasze produkty pozwalają bawić się cieniem i światłem, aby wnętrze wyglądało na większe lub bardziej przytulne.

ar

حسن من البنية المعمارية لغرفتك وأضف أجواء مميزة من خلال حلول الإضاءة غير المباشرة التي تناسب نمطك المفضل. تصميمات بسيطة أو مستوحاة من الطبيعة، إضاءة متجهة لأعلى أو لأسفل، إضاءة خطية أو شعاعية، أيًا كان اختيارك ستتيح لك باقتنا التلاعب بالضوء والظل لتبدو غرفتك أكثر راحة أو لتضفي عليها المزيد من الراحة والدفء.

fr

Soulignez l'architecture de votre pièce et ajoutez de l'ambiance avec des solutions d'éclairage indirect qui correspondent à votre style. Qu'il s'agisse de lumières simples ou organiques, de lumières vers le haut ou vers le bas, linéaires ou diffuses, notre gamme vous permet de jouer avec l'ombre et la lumière pour rendre votre pièce plus grande ou plus confortable.



C323
200 x 5,5 x 4,2 cm
Purotouch®

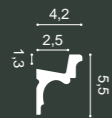

6 C324 AUTOIRE
200 x 8,3 x 3,4 cm
Purotouch®
Designed by
Orio Tonini

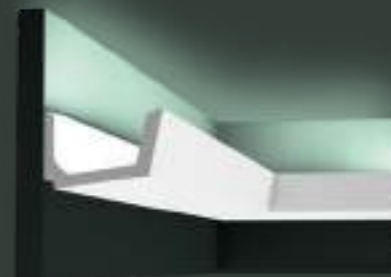
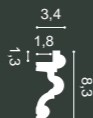

C357 STRAIGHT
200 x 7,1 x 11 cm
Purotouch®
Designed by
Jacques Vergracht

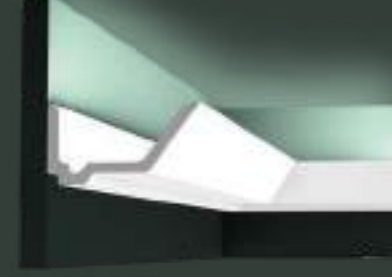

C358 RAIL
200 x 7,3 x 14 cm
Purotouch®
Designed by
Jacques Vergracht

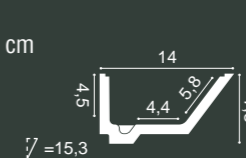

C351 BOAT
200 x 7,4 x 17,3 cm
Purotouch®
Designed by
Jacques Vergracht

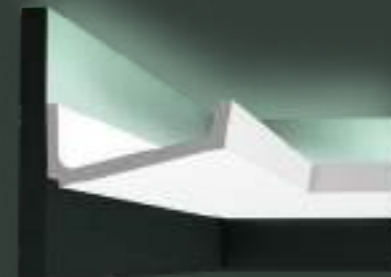
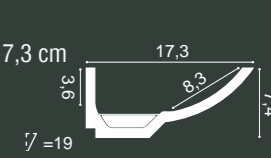

C352 FLAT
200 x 7,6 x 17,1 cm
Purotouch®
Designed by
Jacques Vergracht

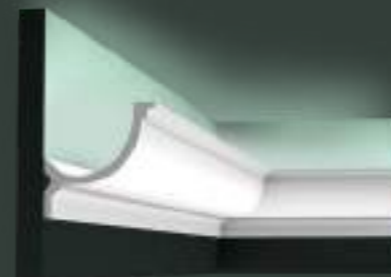
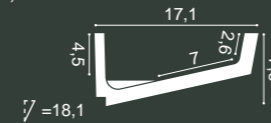

C902 | C902F
200 x 10,3 x 10,3 cm
Purotouch®

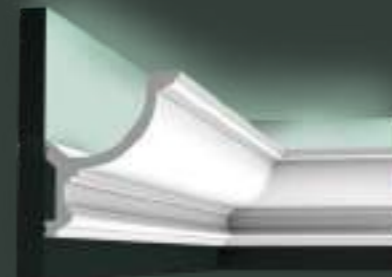
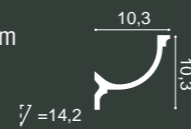

C901 | C901F
200 x 14,8 x 12,4 cm
Purotouch®

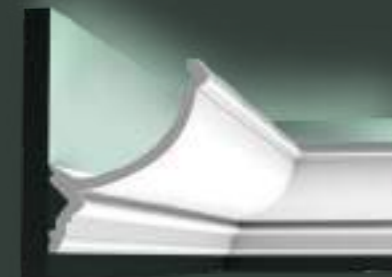
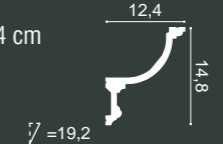

C900
200 x 17,1 x 14,6 cm
Purotouch®

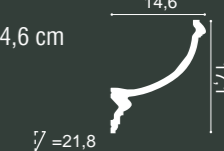

L3 Lighting Combinations

C380

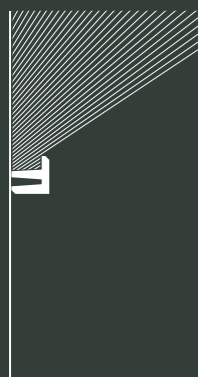

C382 + C380

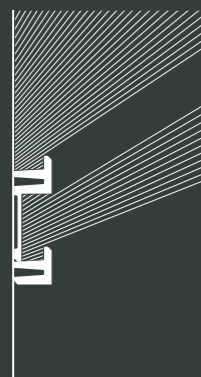

2 C382 + C382 + C380

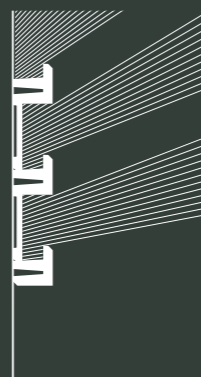

C382 + C382 + C381

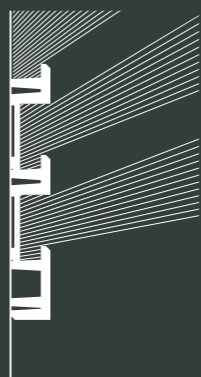

C381

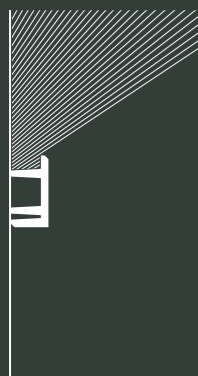

C383 + C381

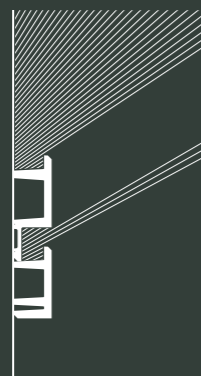

C383 + C383 + C381

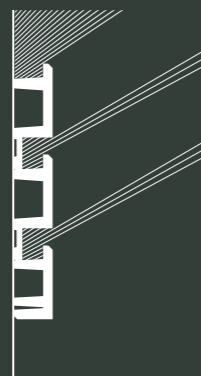

C383 + C382 + C381

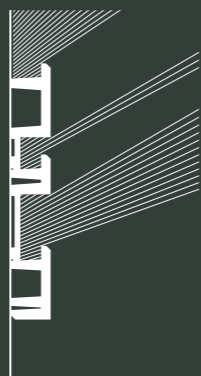

C382 + C383

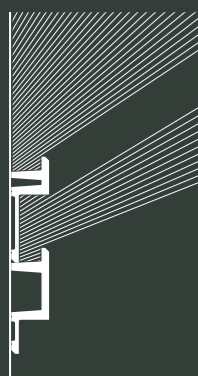

C381 + C382

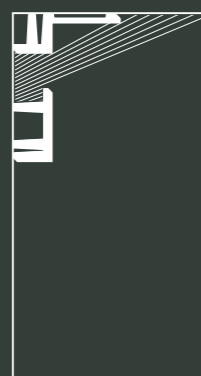

C382 + C382

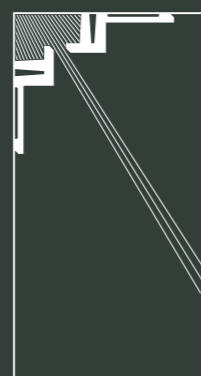

4 C382 + C382 + C382

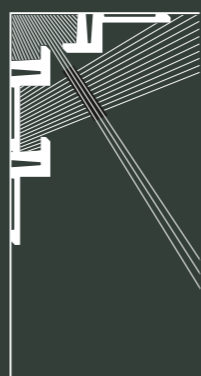

C380 L3 Linear Led Lighting

200 x 5 x 5 cm
Purotouch®

Designed by
Orio Tonini

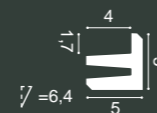

C381 L3 Linear Led Lighting

200 x 9,5 x 5 cm
Purotouch®

Designed by
Orio Tonini

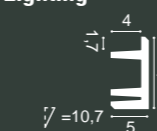

C382 L3 Linear Led Lighting

200 x 14 x 5 cm
Purotouch®

Designed by
Orio Tonini

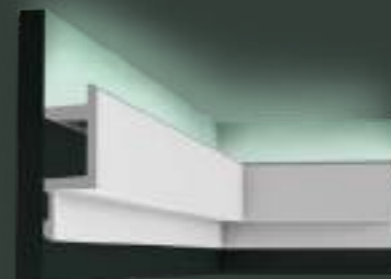
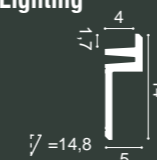

3 C383 L3 Linear Led Lighting

200 x 14 x 5 cm
Purotouch®

Designed by
Orio Tonini

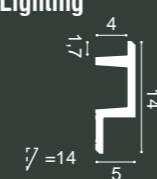

1. SX180 p.102 | 3. C383 p.135

Steps

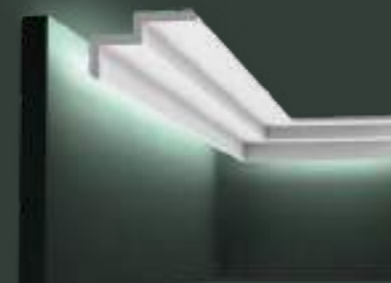

1 C390 STEPS
200 x 6 x 10 cm
Purotouch®
Designed by
Orio Tonini

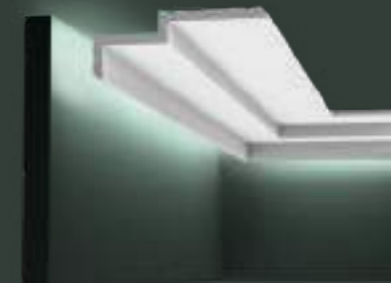
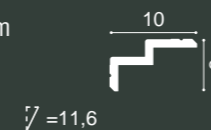

C391 STEPS
200 x 6 x 16 cm
Purotouch®
Designed by
Orio Tonini



C394 STEPS
200 x 9,5 x 3,1 cm
Purotouch®
Designed by
Orio Tonini

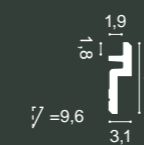

C395 STEPS
200 x 15,5 x 3,1 cm
Purotouch®
Designed by
Orio Tonini



C396 STEPS
200 x 18,5 x 6,1 cm
Purotouch®
Designed by
Orio Tonini

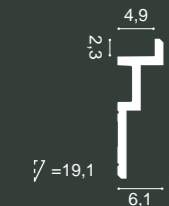

C390

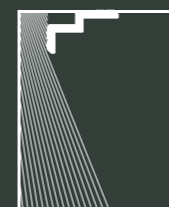

C391

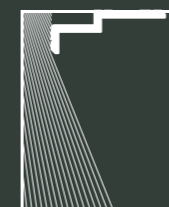

C394

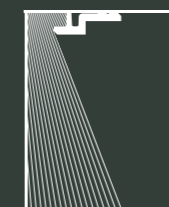

C395

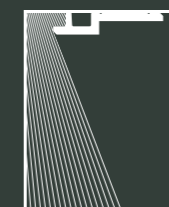

C394

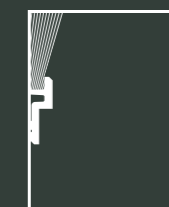

C395

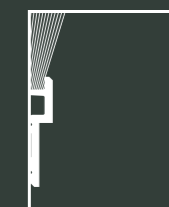

C396

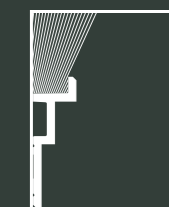

DOWNLIGHTER

UPLIGHTER





CX190 | CX190F U-PROFILE
200 x 2 x 3 cm
Duropolymer®
Designed by
Orio Tonini

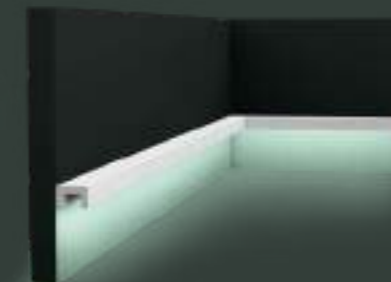

CX190 | CX190F U-PROFILE
200 x 2 x 3 cm
Duropolymer®
Designed by
Orio Tonini

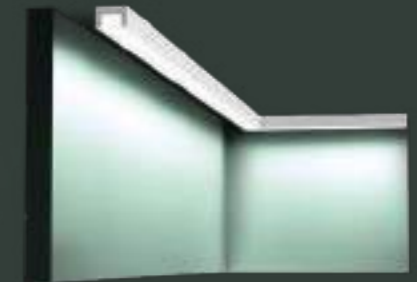

2 CX190 | CX190F U-PROFILE
200 x 2 x 3 cm
Duropolymer®
Designed by
Orio Tonini

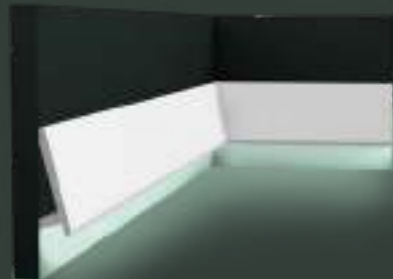

SX179 DIAGONAL
200 x 9,7 x 2,9 cm
Duropolymer®
Designed by
Orio Tonini



SX179 DIAGONAL
200 x 9,7 x 2,9 cm
Duropolymer®
Designed by
Orio Tonini

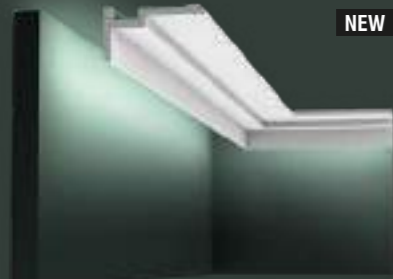
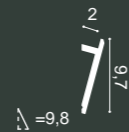

CX197 U-STEPS
200 x 5 x 9,3 cm
Duropolymer®
Designed by
Orio Tonini



CX196 U-STEPS
200 x 11,3 x 4 cm
Duropolymer®
Designed by
Orio Tonini



CX188 | CX188F
200 x 3,4 x 3 cm
Duropolymer®
Designed by
Orio Tonini



CX189 | CX189F
200 x 2,7 x 2,7 cm
Duropolymer®
Designed by
Orio Tonini



1. SX180 p.102 | 2. CX190 p.138

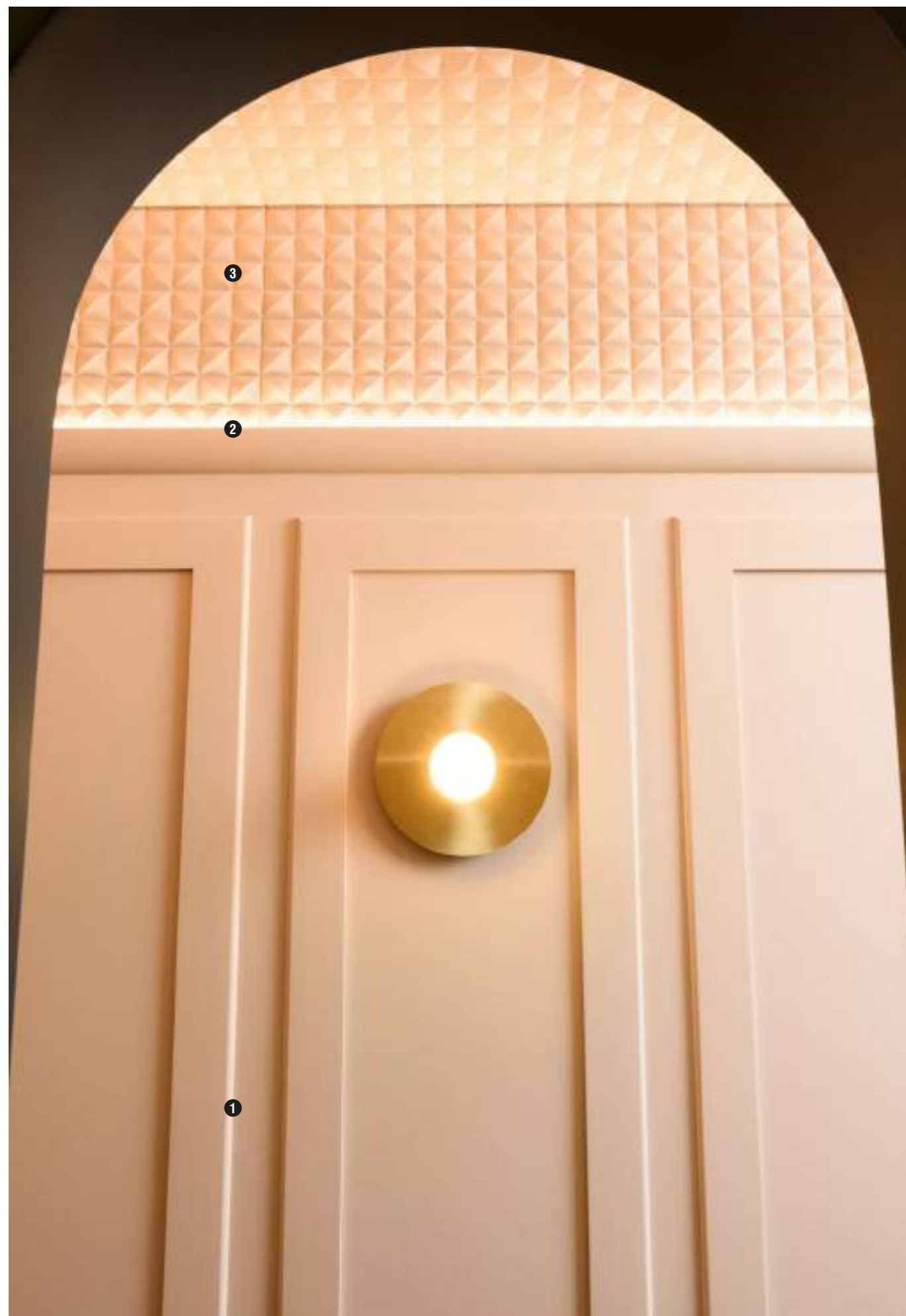

2 C373 | C373F ANTONIO
200 x 8 x 5 cm
Purotouch®
Designed by
Ulf Moritz

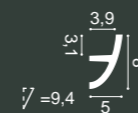

C374 ANTONIO
200 x 18 x 5 cm
Purotouch®
Designed by
Ulf Moritz

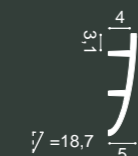

C373 + C374

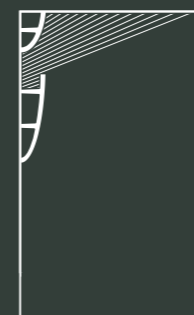

C373 + C373

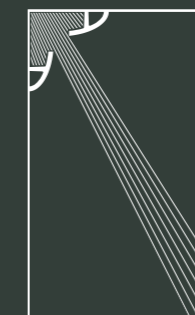

C374 + C991

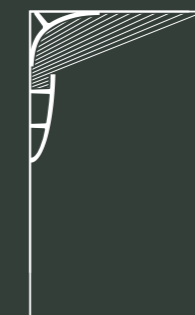

C373 + C373

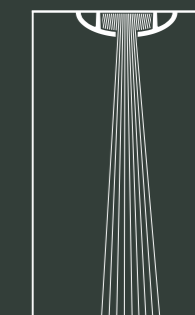

C374 + C374

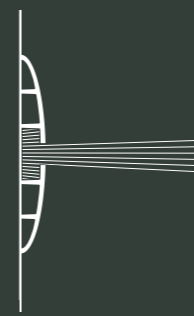

C373 + C374

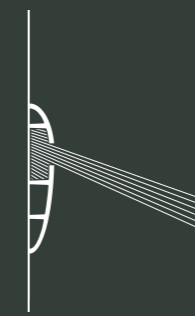

C373 + C373

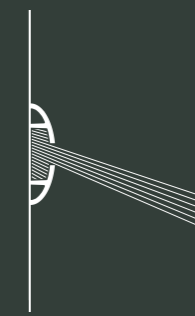

C374 + C373



C373 + C374

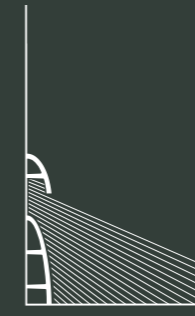

C374 + C374



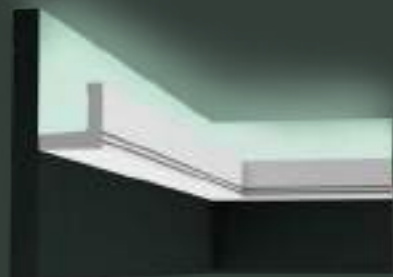

C361 STRIPE

200 x 5 x 5 cm
Purotouch®

Designed by
Pierre Daems



C362 CURVE

200 x 5 x 5 cm
Purotouch®

Designed by
Pierre Daems

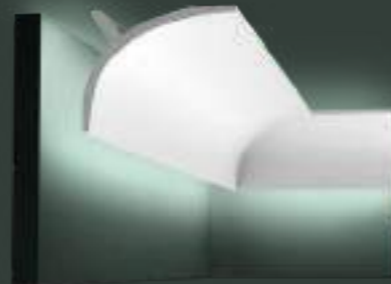
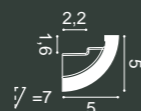

C991

200 x 11 x 14 cm
Purotouch®

Designed by
Pierre Daems

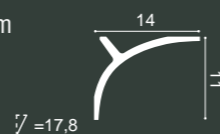

C364 WAVE

200 x 14 x 8 cm
Purotouch®

Designed by
Pierre Daems

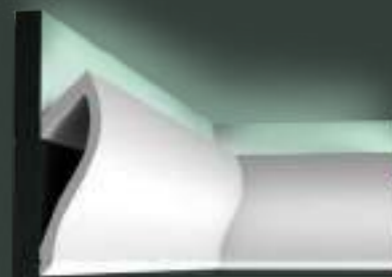
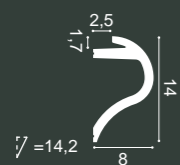

C371 SHADE

200 x 18,5 x 5,8 cm
Purotouch®

Designed by
Ulif Moritz

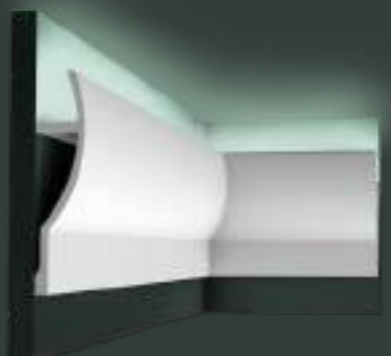
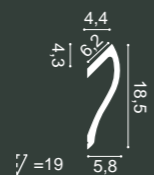

C372 FLUXUS

200 x 28 x 7 cm
Purotouch®

Designed by
Ulif Moritz



1. SX191 p.95 | 2. P4025 p.106 | 3. C991 p.142 | 4. F30 p.129



The Perfect Finish
PG. 154-155

Deco Elements

ДЕКОРАТИВНЫЕ ЭЛЕМЕНТЫ

ELEMENTY DEKORACYJNE

أصناف للزينة / ÉLÉMENTS DÉCORATIFS



en —

Add a sophisticated final touch to your walls with our deco elements. Ranging from door frames, columns and pilasters to ceiling roses, these elements give your walls elegance, beauty and style that match your vision and budget.

ru —

Наши декоративные элементы добавят изысканный завершающий штрих вашим стенам. От дверных рам, колонн и пилястров до потолочных розеток – эти элементы придадут стенам элегантность, красоту и стиль в соответствии с вашим видением и бюджетом.

pl —

Nasze elementy dekoracyjne mogą stanowić wyrafinowane wykończenie Twoich ścian. Futryny drzwiowe, kolumny i pilastry czy rozety sufitowe – takie elementy nadają ścianom elegancji, piękna i stylu zgodnie z Twoją wizją i budżetem.

ar —

أضف لمسة نهائية رفيعة المستوى إلى جدرانك مع العناصر الزخرفية الخاصة بنا. بدايةً من إطارات الأبواب والأعمدة والأعمدة الجدارية إلى ورود السقف، تضيفي هذه العناصر الزخرفية على جدرانك أناقة وجمالاً وأسلوباً يتناسب مع رؤيتك وميزانيتك.

fr —

Ajoutez une touche finale sophistiquée à vos murs avec nos éléments décoratifs. Des encadrements de porte, colonnes et pilastres aux rosaces de plafond, ces éléments confèrent à vos murs élégance, beauté et style, qui correspondent à votre vision et à votre budget.



R13 ⊕
ø 28 x 3,1 - ø 2,5 cm
Purotouch[®]



R14 ⊕
ø 33 x 3 - ø 2,5 cm
Purotouch[®]



R31 ⊕
ø 38,5 x 2,7 - ø 3,5 cm
Purotouch[®]



R17 ⊕
ø 47 x 3,5 - ø 6,5 cm
Purotouch[®]



R18
ø 49 x 4,7 - ø 7 cm
Purotouch[®]



R52 ⊕
ø 69,5 x 4,8 - ø 12,5 cm
Purotouch[®]



R73 ⊕
ø 70 x 5,9 - ø 8 cm
Purotouch[®]



R23
ø 71 x 4,4 - ø 6 cm
Purotouch[®]



R27
ø 75 x 4,5 - ø 9 cm
Purotouch[®]

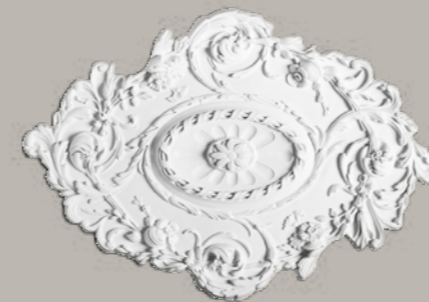

R22
77,5 x 53 x 3,6 cm
Purotouch[®]



R24
ø 79 x 6 - ø 8 cm
Purotouch[®]



R64 ⊕
ø 95,2 x 4,8 - ø 7 cm
Purotouch[®]



R10 ⊕
ø 15 x 4,2 - ø 2 cm
Purotouch[®]



R11
ø 19 x 3,6 - ø 3 cm
Purotouch[®]



R12
ø 19,5 x 1,8 - ø 1 cm
Purotouch[®]

1. R10 p.146 | 2. R31 p.147 | 3. R17 p.147 | 4. R52 p.147



R07
ø 26 x 3 - ø 5 cm
Purotouch[®]

1 R08
ø 38 x 4,2 - ø 5 cm
Purotouch[®]

R09 ⊕
ø 48,5 x 3,7 - ø 6 cm
Purotouch[®]



R66
ø 54,5 / 43 x 2,4 cm
Purotouch[®]

R76
ø 62 x 4,1 - ø 10,5 cm
Purotouch[®]

R77
ø 62 x 4,2 - ø 10,5 cm
Purotouch[®]



R40 ⊕
ø 74,5 x 3,1 - ø 10 cm
Purotouch[®]

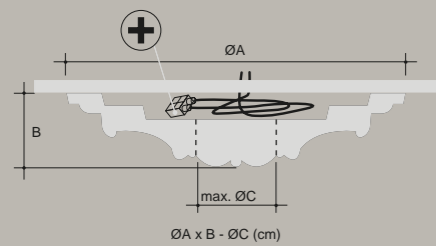

⊕ ROOM FOR CABLES
Место для кабеля
Przestrzeń na kable
مكان للكابلات
Place pour les câbles



1. R08 p.148

DOOR FRAMES / ДВЕРНОЕ ОБРАМЛЕНИЕ / OBRAMOWANIA DRZWIOWE
إطارات للأبواب / ENCADREMENTS DE PORTES

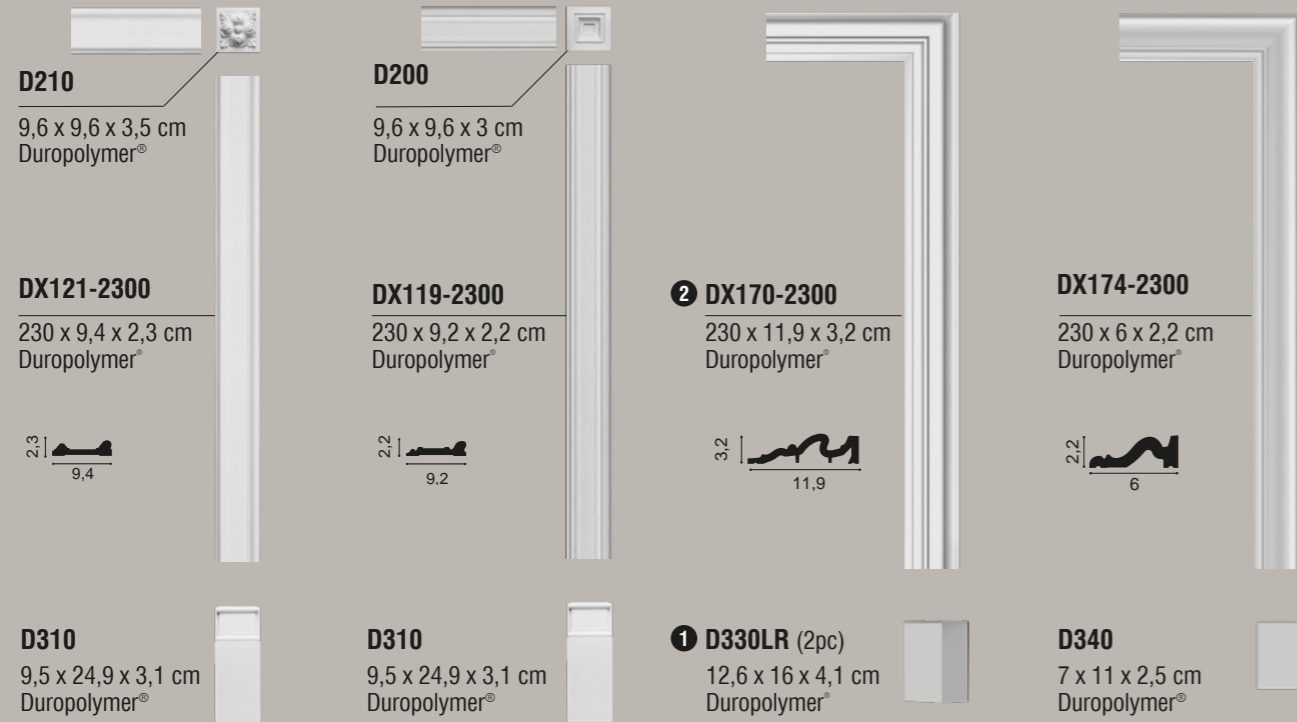

PEDIMENTS / ФРОНТОНЫ / FRONTONY / أقواس / FRONTONS

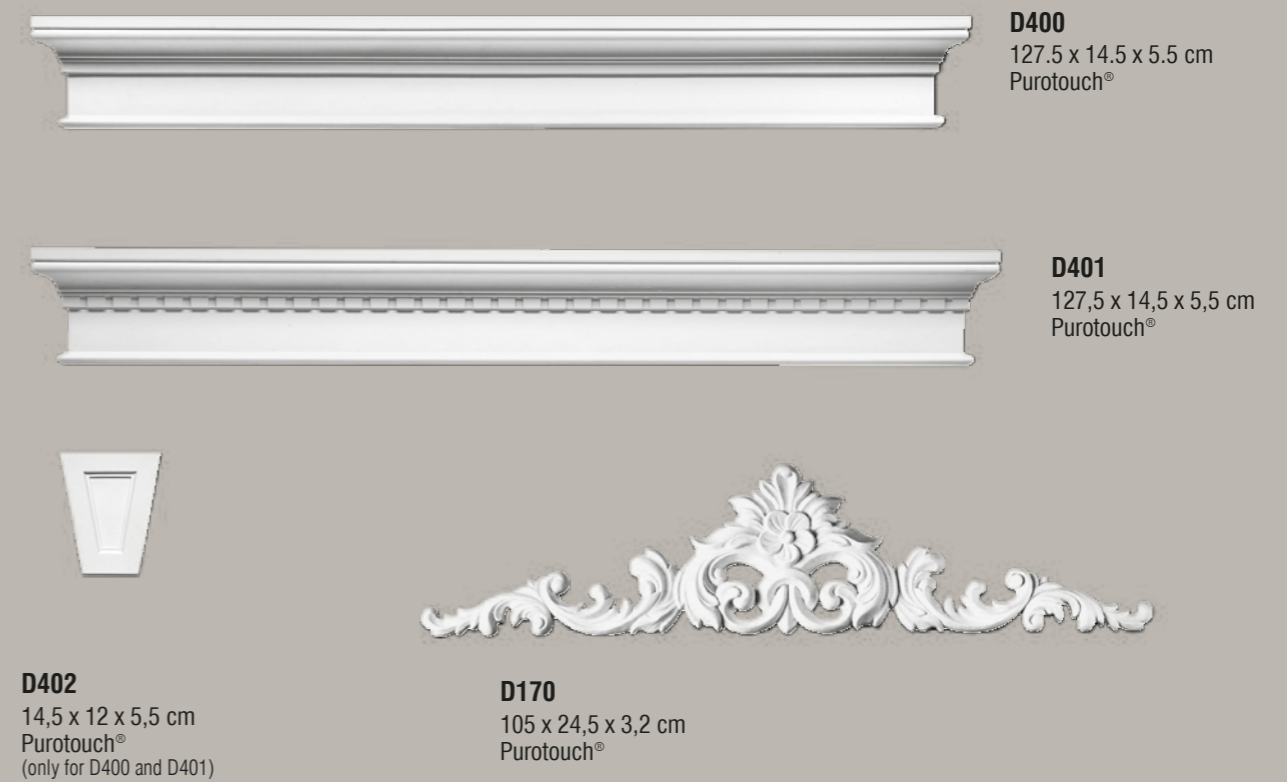

150



1. D330LR p.150 | 2. DX170-2300 p.150

DOOR PANELLING / ПАНЕЛЬНАЯ ОБШИВКА ДВЕРЕЙ / PANELE DRZWIOWE
تلييسة الباب / PANNEAUX D E PORTES



151

FULL COLUMNS / КОЛОННЫ
PEŁNE KOLUMNY / أعمدة كاملة
COLONNES ENTIÈRES

HALF COLUMNS / ПОЛУКОЛОННЫ
PÓŁKOLUMNY / نصف أعمدة
DEMI-COLONNES

PILASTERS / ПИЛЯСТРЫ / PILASTRY
أعمدة مسطحة للجدران / PILASTRES

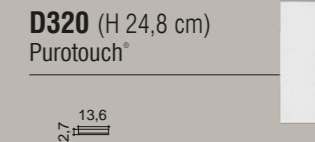
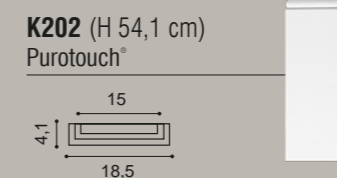
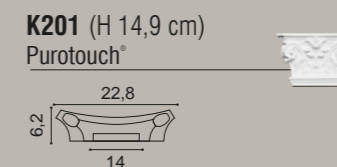
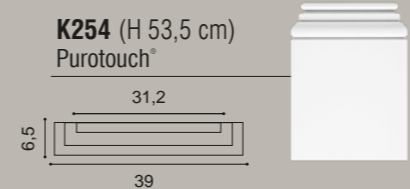
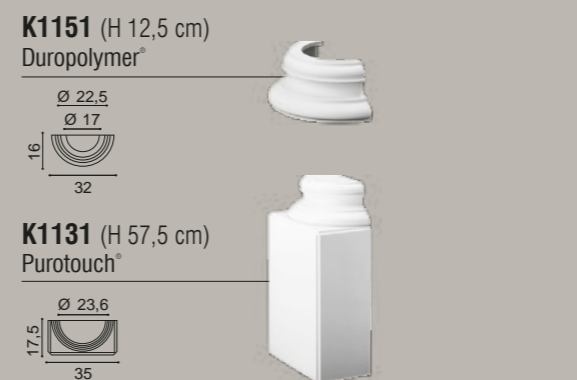
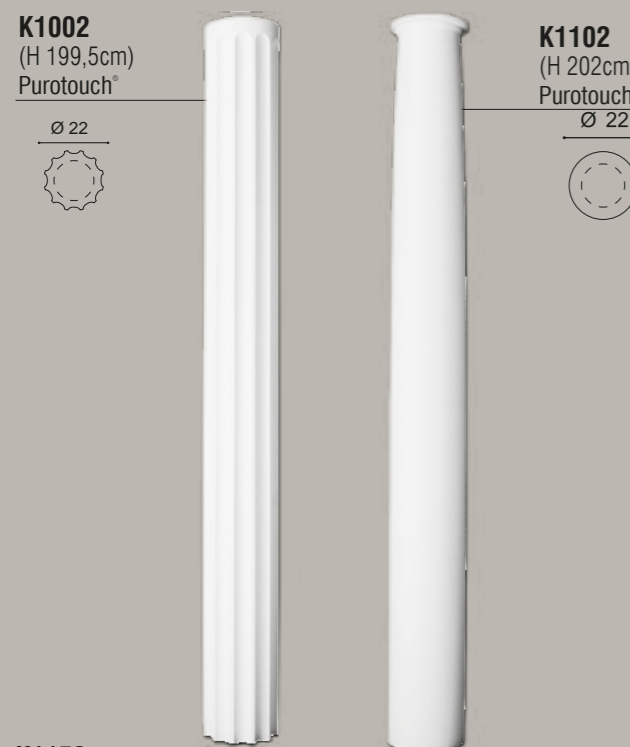
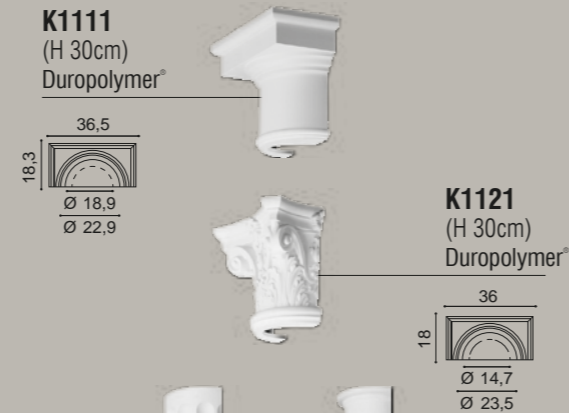

K1112 + K1002 + K1152 = 242 cm H
K1112 + K1002 + K1132 = 287 cm H max
K1122 + K1102 + K1152 = 242 cm H
K1122 + K1102 + K1132 = 287 cm H max

K1111 + K1001 + K1151 = 242 cm H
K1111 + K1001 + K1131 = 287 cm H max
K1121 + K1101 + K1151 = 242 cm H
K1121 + K1101 + K1131 = 287 cm H max



The Perfect Finish

Идеальный финиш / Idealne wykończenie
مظهر نهائي مثالي / La finition parfaite

Ready? Set? Go!
✓ INSTALLATION WARRANTY

ONLY FULL GUARANTEE WITH DECOFIX
ГАРАНТИЯ НА ПРОДУКЦИЮ ДЕЙСТВУЕТ ТОЛЬКО ПРИ ИСПОЛЬЗОВАНИИ КЛЕЯ DECOFIX
PEŁNA GWARANCJA TYLKO Z KLEJEM DECOFIX
ضمانة كاملة فقط مع ديكوفيكس
GARANTIE TOTALE UNIQUEMENT AVEC COLLE DECOFIX

Ready? SURFACE & ATMOSPHERE

Поверхность и окружающая среда | Powierzchnia i atmosfera | السطح والمحيط | Environnement & Surface



Storage and installation conditions: Store profiles and adhesives at room temperature and wait 24 hours before installing.

Условия хранения и монтажа: Оставьте профили и клей в комнате, которой планируется монтаж, на 24 часа.
Warunki przechowywania i użycia kleju: profile i kleje przechowywać w temperaturze pokojowej, odczekać 24 godziny przed instalacją.
شروط التخزين والتثبيت: يجب وضع القوالب والمواد اللاصقة في درجة حرارة الغرفة ٤٢ ساعة قبل التركيب.
Conditions d'installation et de stockage: Stockez les profils et les colles à température ambiante 24 heures avant la pose.



Set? DECOFIX ADHESIVES

Клей DecoFix | Kleje DecoFix | المواد اللاصقة ديكوفيكس | Colles DecoFix

Interior, porous and dry surface
Подходит для внутренних работ, пористых и сухих поверхностей | Wewnątrz, do powierzchni porowatych i suchych |
powierzchni porowatych i suchych |
Pose à l'intérieur, surfaces poreuses, pièces non humides



Heavy profile
Тяжелый профиль
Duże profile
قوالب ثقيلة
Profils lourds

Exterior, non-porous and humid surface
Подходит для наружных работ, непористых и влажных поверхностей | Na zewnątrz, do powierzchni nieporowatych i wilgotnych |
سطح خارجي، غير مسامي ورطب
surfaces non poreuses, environnement humide



DecoFix Pro
Strong, water-based acrylic installation adhesive
FDP500 310ml | 7 > 8m
FDP600 4200ml | 65 > 110m

DecoFix Power
Very strong MS-Polymer-based installation adhesive
FDP700 290ml | 7 > 8m

DecoFix Extra
Polyurethane-based adhesive
FX200 310ml | min. 80m
FX210 tube 80ml | min. 20m

*For Durofoam®: use DecoFix Pro for joints
используйте стыковочный клей DecoFix | Do przyklejania Durofoam® (pianki Duro) | لدوروفوم: يجب إستعمال ديكوفيكس برو لملء الفواصل | Pour Durofoam®: utilisez DecoFix Pro pour les joints

DecoFiller
Acrylic filler
FL300 310ml | > 30m

DecoFix Pro

FDP500 310ml
> 7 - 8m
FDP600 4200ml
> 65 - 110m



Extra strong installation adhesive for porous surfaces and interior applications
· Strong, water-based acrylic glue
· Long-lasting seal between mouldings and the wall and/or ceiling
· Remove with humid sponge or cloth
· Should be kept frost free
· Paintable after hardening (min. 24 hours)

DecoFix Power

FDP700 290ml
> 7 - 8m



Extra strong MS polymer glue for new build, all exterior applications, non-porous (tiles, glass, ...) surfaces and damp environments
· Remove with soap solution
· Paintable after hardening (min. 24 hours)

DecoFix Extra

FX200 310ml
> 80m
FX210 80ml
> 20m



Polyurethane-based glue to seam joints between mouldings
· Remove excess glue before hardening (max. 1 hour and repeat after 2-3 hours)
· Clean with acetone or Synth Thinner
· Can be painted after 24 hrs
· The more humidity, the faster the drying time

DecoFiller

FL300 310ml
> 30m



Ready to use lightweight acrylic filler
· For shrink-proof finishing of gaps (between decorative profiles after adhesion, between wall and profiles, between walls and between wall and ceiling), cracks and irregularities in profiles or on walls
· Rapidly repaintable (after 15 min.)
· Does not crack

en

ru

pl

ar

fr

Wyjątkowo mocny klej instalacyjny do aplikacji we wnętrzach na porowatych powierzchniach
· Mocny, akrylowy klej na bazie wody
· Długotrwałe uszczelnienie pomiędzy listwami, a ścianami lub sufitami
· Nadmiar usuwać za pomocą wilgotnej gąbki lub szmatki
· Chronić przed mrozem
· Nadaje się do malowania po całkowitym stwardnieniu (min. 24 godz.)

Wyjątkowo mocny klej MS polimerowy do konstrukcji nowa, stosowania na zewnątrz, na gładkich powierzchniach (płytki, szkło itp.) w wilgotnym środowisku
· Usuwać roztworem z mydła
· Nadaje się do malowania po całkowitym stwardnieniu (min. 24 godz.)

Poliuretanowy klej do łączeń pomiędzy listwami
· Nadmiar kleju usuwać przed stwardnieniem (maks. 1 godz., powtórzyć po 2-3 godz.)
· Czyścić acetonem lub syntetycznymi rozpuszczalnikami
· Nadaje się do malowania po 24 godz.
· Wyższa wilgotność skraca czas schnięcia

Gotowy do użycia lekki wypełniacz akrylowy
· Do niekurczliwego wykańczania szczelin (pomiędzy profilami ozdobnymi po przyklejeniu, między ścianami i profilami, pomiędzy ścianami oraz ścianami i sufitem), a także pęknięć i nierówności w profilach lub na ścianach
· Możliwość szybkiego ponownego malowania (po 15 min.)
· Nie pęka

لاصق قوي جدا لتثبيت القوالب على أسطح مسامية وفي الداخل
· لاصق أكريليك قوي، أساسه ماء
· لاصق متين بين القوالب والجدار والسقف
· يزال بإسفنجة أو قماش رطب
· يحفظ ممحبا من الجليد
· يمكن طلاؤه بعد أن يصلب (٢٤ ساعة على الأقل)

لاصق م.س. بوليمر قوي جدا لتثبيت القوالب في الخارج، في أماكن رطبة، وعلى أسطح غير مسامية (بلاط، زجاج...)
· يزال بالماء والصابون
· يمكن طلاؤه بعد أن يصلب (٢٤ ساعة على الأقل)

لاصق بوليوريثان للصلق الفواصل بين القوالب
· يزال فائض الغراء قبل أن يصلب (١ ساعة max. وتكرر بعد ٢-٣ ساعات)
· ينظف بأسيطون أو مرقق إصطناعي
· يمكن طلاؤه بعد ٢٤ ساعة
· ينشف بسرعة أكبر مع إرتفاع درجة الرطوبة

معدونة أكريليك خفيفة الوزن جاهزة للإستخدام
· ملء الشقوق وغيرها من العيوب في القوالب أو الجدران
· بين القوالب بعد لقصها، بين القوالب والجدار، بين الجدران وبين الجدار والسقف
· قابلة للطلاء بسرعة (بعد ٥١ دقيقة)
· غير قابلة للإتكماش أو التشنق

Colle d'installation ultra forte pour surfaces poreuses et applications intérieures
· Colle forte à base d'eau et d'acrylique
· Joint longue durée entre les moulures et le mur et/ou le plafond
· Retirez à l'aide d'une éponge ou d'un chiffon humide
· Doit être conservée à l'abri du gel
· Peut être peinte après séchage (min. 24 heures)

Colle au MS polymère extra forte pour constructions nouvelles, utilisation extérieure, surfaces non poreuses (carrelage, verre, etc...) et environnements humides
· Enlevez à l'aide d'une solution savonneuse
· Peut être peinte après séchage (min. 24 heures)

Colle polyuréthane pour l'assemblage des joints entre les moulures
· Éliminez les excès de colle avant le durcissement (1 heure max. et recommencez après 2-3 heures)
· Nettoyez avec de l'acétone ou un diluant synthétique
· Peut être peint après 24 h
· Un taux d'humidité plus élevé peut accélérer le temps de séchage

Enduit léger prêt à l'emploi à base d'acrylique
· Pour une finition irréversible de joints (entre profils décoratifs après adhésion, entre murs et profils, entre mur et plafond et murs entre eux), fissures, trous et irrégularités dans les profils ou les murs
· Peut être recouvert rapidement (après 15 min.)
· Ne se fissure pas

ACCESSORIES | Аксессуары | Akcesoria | لوازم | Accessoires



FB15

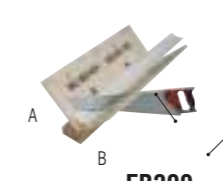

FB300
A: 29,7 cm
B: 29,1 cm

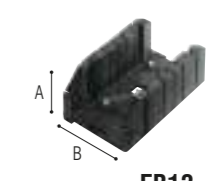

FB13
A: 12,5 cm
B: 15,5 cm



A38



FB14
A: 60 cm



FB10
A: 27,5 cm - B: 22 cm

Go! INSTALLATION VIDEOS & MANUALS

DECOFIX GLUE CALCULATOR



SCAN THE QR CODE
OR VISIT
WWW.ORACDECOR.COM > INSTALLATION



Flexible Products

Flex Radius	R min in cm	R* min in cm	R**min in cm	Flex Radius	R min in cm	R* min in cm	R**min in cm	Flex Radius	R min in cm	R* min in cm	R**min in cm
C211F	250			DX174F	60	300		SX180F	45		
C213F	280			P3020F	50	180		SX182F	35	100	
C215F	160			P4020F	40	200		SX183F	40		
C217F	380			P4025F	70			SX184F	45		
C220F	400			P5021F	20	70		SX187F	40		
C230F	150			P7070F	30	230		SX194F	25	80	
C240F	270			P8020F	40	130		SX195F	30		
C250F	70			P8030F	20	70		W108F	40		30
C304F	250			P8040F	30			W109F	40		30
C321F	140			P8050F	80	200		W110F	40		30
C325F	300			P9010F	40	310		W111F	40		30
C326F	500			P9050F	20	60		W114F	40		30
C331F	420			P9900F	20	250		W116F	40		30
C333F	300			PX103F	20	80					
C334F	380			PX120F	30	110					
C339F	380			PX144F	20	220					
C341F	400			PX175F	30	80					
C373F	100			PX198F	70						
C901F	600			PX201F	30	80					
C902F	600			PX202F	60	150					
CX100F	200			SX104F	40						
CX106F	360			SX105F	30						
CX109F	160			SX118F	40						
CX110F	180			SX137F	40						
CX123F	280			SX138F	40						
CX124F	160			SX155F	30						
CX127F	240			SX157F	35	260					
CX132F	70			SX162F	20	80					
CX188F	110			SX163F	35						
CX189F	90			SX165F	40						
CX190F	30	130		SX172F	35						
CX199F	200			SX173F	45						

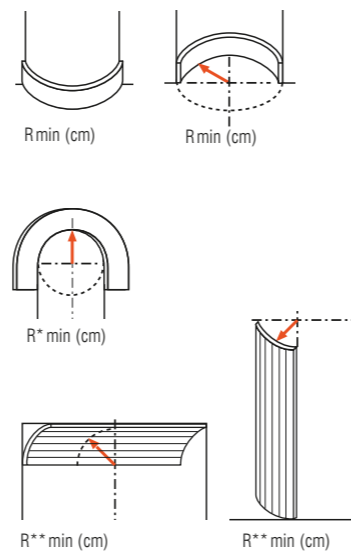

en —

A wide range of cornice mouldings, panel mouldings and skirting boards are available in a flexible variant to give curved walls and ceilings an elegant finish. These elements are also light and can be painted.

The sky is the limit: add curved lines and circles to your walls and ceilings in no time.

ru —

Широкий ассортимент гибких карнизов, молдингов и плинтусов позволяет оформить округлые стены и потолки. Эти профили лёгкие и легко окрашиваются.

Воозможности безграничны: добавьте плавных линий и округлости вашим стенам и потолкам за мгновение ока.

pl —

Dostępna szeroka gama listew przysufitowych, ściennych i przypodłogowych daje możliwość eleganckiego wykończenia krzywymi ścianom i sufitom. Elementy te są jasne i mogą być malowane.

Jedynym ograniczeniem jest wyobraźnia: dodaj do ścian i sufitów pozakrzywiane, zaokrąglone linie i okręgi.

ar —

مجموعة واسعة من الكرانيش، قوالب الجدران والتعلات متوفرة لإعطاء الجدران والسقوف المقوسة مظهر أنيق. هذه الأصناف هي أيضا خفيفة الوزن ويمكن طلاؤها. السماء هي الحد: أضيفوا خطوط منحنية ودوائر إلى الجدران والسقوف بسرعة وسهولة.

fr —

De nombreuses corniches, cimaises et plinthes sont disponibles dans des modèles variés. Les murs et plafonds courbes peuvent également bénéficier d'une finition élégante. En outre, ils sont clairs et peuvent être peints!

Vous n'auriez jamais imaginé qu'il serait aussi facile d'installer des lignes courbes et des cercles au mur et au plafond.

Index

C

C200	67
C201	71
C211 C211F	70
C212	71
C213 C213F	67
C215 C215F	67
C216	67
C217 C217F	67
C219	71
C220 C220F	67
C230 C230F	67
C240 C240F	74
C250 C250F	74
C260	74
C301	67
C303	71
C304 C304F	71
C305	70
C305 + C211	70
C305 + C213	70
C307	70
C307 + C307A	70
C308	71
C321 C321F	72
C322	67
C323	132
C324	132
C325 C325F	65
C326 C326F	65
C327	65
C331 C331F	68
C332	72
C333 C333F	68
C334 C334F	68
C335	68
C336	66
C338	66
C338A	66
C338B	66
C339 C339F	72
C340	72, 81
C341 C341F	64, 81
C342	64, 81
C343	64, 81
C344	64
C351	133
C352	133
C353	78
C354	78
C355	78
C356	78

C357	133
C358	133
C360	78
C361	142
C362	142
C364	142
C371	142
C372	142
C373 C373F	141
C374	141
C380	135
C381	135
C382	135
C383	135
C390	77, 81, 137
C391	77, 81, 137
C392	77
C393	77
C394	77, 81, 137
C395	77, 81, 137
C396	77, 81, 137
C400	78
C422	70
C602	78
C900	68, 133
C901 C901F	68, 133
C902	133
C902 C902F	68
C990	75
C990 + 2x P9900	75
C990 + P9900	75
C991	74, 81, 142
C991 + 2x P9900	74
C991 + P9900	74
CB500	87
CB501	87
CB502	87
CB503	87
CB510	87
CB511	87
CB512	87
CB520	87
CB521	87
CB522	87
CB523	87
CB524	87
CB525	87
CB530	87
CB531	87
CX100 CX100F	82
CX101	83
CX106 CX106F	82
CX107	83
CX108	83

CX109 CX109F	84
CX110 CX110F	83
CX111	83
CX112	83
CX115	84
CX123 CX123F	82
CX124 CX124F	82
CX126	84
CX127 CX127F	82
CX128	83
CX129	83
CX132 CX132F	84, 98
CX133	84, 98
CX134	113
CX141	84
CX148	84
CX154	83
CX160	86
CX161	86
CX176	84
CX177	83
CX188 CX188F	138
CX189 CX189F	138
CX190 CX190F	85, 98, 102, 112, 139
CX192	84
CX196	81, 85, 138
CX197	81, 85, 112, 138
CX199 CX199F	82
CX203	82

D

D170	151
D200	150
D210	150
D310	150
D320	153
D330LR	150
D340	150
D400	151
D401	151
D402	151
D503	151
D504	151
D506	151
D507	151
DX119-2300	110, 150
DX121-2300	110, 150
DX157-2300	150
DX163-2300	150
DX170-2300	110, 150
DX174-2300	150
DX174-2300 DX174F	110

F

F30	129
-----	-----

K

K200	153
K201	153
K202	153
K250	153
K251	153
K254	153
K1001	152
K1002	152
K1101	152
K1102	152
K1111	152
K1112	152
K1121	152
K1122	152
K1131	152
K1132	152
K1151	152
K1152	152

P

P20	115
P101A	115
P801C	115
P1020	107
P3020A	115
P3020 P3020F	107
P3070	108
P3071	108
P4020A	115
P4020 P4020F	106
P4025 P4025F	106
P5020	108
P5020B	115
P5021 P5021F	108
P6020	107
P7020	107
P7030	107
P7070 P7070F	108
P8020 P8020F	106
P8030C	115
P8030D	115
P8030 P8030F	106
P8040 P8040F	106
P8050 P8050F	106
P8060	108
P9010 P9010F	106
P9020	106
P9040	106
P9050 P9050F	108
P9900 P9900F	108
P9901	108
PB513	87

PX102	111
PX103 PX103F	111
PX103A	115
PX113	111
PX116	111
PX117	111
PX120 PX120F	111
PX120A	115
PX144 PX144F	111
PX147	112
PX164	86
PX169	112
PX175 PX175F	111
PX198 PX198F	85, 98, 102, 112
PX201 PX201F	111
PX202 PX202F	111

R

R07	148
R08	148
R09	148
R10	146
R11	146
R12	146
R13	147
R14	147
R17	147
R18	147
R22	147
R23	147
R24	147
R27	147
R31	147
R40	148
R52	147
R64	147
R66	148
R73	147
R76	148
R77	148

S

SX104 SX104F	95
SX105 SX105F	96
SX118 SX118F	93
SX122	94
SX125	99
SX137 SX137F	94
SX138 SX138F	94
SX155 SX155F	96
SX156	95
SX157 SX157F	86, 93, 102, 113
SX159	99, 103, 111
SX162 SX162F	86, 93, 102, 113
SX163 SX163F	86, 93, 103, 113
SX165 SX165F	93
SX168	103, 113

SX171	93, 101
SX172 SX172F	99
SX173 SX173F	93
SX179	99, 138
SX180 SX180F	97, 102
SX181	97, 102
SX182 SX182F	86, 93, 103
SX182 SX182F	113
SX183 SX183F	86, 93, 103, 113
SX184 SX184F	86, 93, 103
SX185	93, 101
SX186	93, 101
SX187 SX187F	97, 102
SX191	95
SX193	94
SX194 SX194F	85, 98, 102, 113
SX195 SX195F	96

W

W100	128
W101	128
W102	128
W103	128
W105	128
W106	128
W107	128
W108 W108F	118
W109 W109F	118
W110 W110F	118
W111 W111F	118
W112	122
W113	122
W114 W114F	121
W116 W116F	121
W120	126
W121	126
W122	126
W123	126
W130	120

CONCEPT

WeWantMore
Gazeuse.be

GRAPHICS

Gazeuse.be

SPECIAL THANKS TO

Sur Mesure Interieur	www.surmesure-interieur.be	4, 27, 44-45, 107
dejaegerinterieurarchitecten	www.dejaegerinterieurarchitecten.be	4-5, 18, 28-29
Marie-Emilie Geerinckx	www.marieemiliegeerinckx.be	5, 18, 136
Ligne Pure	www.lignepure.be	8
Heerenhuis Manufactuur	www.heerenhuis.be	8,12-13
Ethnicraft	www.ethnicraft.com	8, 96
Authentic and so	www.authenticandso.com	12-13
PR Living	www.prliving.com	14-15
Limited Edition	www.le.be	14-15
Taps & Baths	www.badwinkel.be	19
The Hoxton Paris	www.thehoxton.com/paris	19
Ton sur Ton	www.tonsurton.be	19, 50-51, 125
Simon De Backere	www.simondebackere.be	19, 50-51, 125
Joana Sultan_Agence Gabeli	www.agence-gabeli.fr	20,26,40,46
Atelier DAAA	www.atelierdaaa.com	21,24-25,41,66
Adriana Nicolau	www.adriananicolau.es	32-33
CASA DECOR Madrid	www.casadecor.es	37, 69, 79, 85, 114, 129, 143
Dica	www.dica.es	37, 69
Frederiek Van Pamel	www.frederiekvanpamel.be	38-39
WeWantMore	https://wewantmore.studio/	47
Boulangerie Henri	www.boulangerie-henri.be	52-53
Hotel Astoria	www.hotelastoria.be	54-55
Crevits Decoraties	www.crevits-decoraties.be	54-55
Danny Hoorelbeke	www.projectvijf.be	54-55
Pillows Grand Boutique Hotel Reylof	www.pillowshotels.com/ghent	56-57
Rietveld Projects	www.rietveldprojects.be	60, 97
Balo	www.balo.be	71, 92
Restaurant Du Progrès	www.duprogres.be	77
Ele Room 62	https://eleroom62.com/	79
Virginia Sánchez Interiorismo	www.virginiasanchezinteriorismo.com	85
Groep Versluys	www.groepversluys.be	100
Alexandra Chigintseva, Igor Gulyaev	www.chigintseva.ru	103
Virginia Gasch	http://vgliving.com/	114
Ekaterina Pozdnyakova	www.pozdnyakovadesign.ru	128
Marisa Gallo	https://interiorisimo.com/	129
Bontemps-Les Espaces;	www.bontemps.es	143
Soledad Ordóñez Giordano	www.dehuiskamer.be	146
De Huiskamer	info@nsdeco.be	146
Syngedaww Nicolas	www.palomapachecoturnes.com	32-33
Paloma Pacheco Turnes	www.bertdemasure.com	34-35,80,150
Bert Demasure	www.cafeine.be	
Cafeine	www.frederikvercruysse.com	47
Frederik Vercruysse	www.verne.be	
Verne		
& Jill, Brecht-Alexander, Laura, Leon en Heloise		

REGISTERED CTM DESIGN N°

C323/006632071-0001	C364/1890526-0004	CB512/1890526-0007	P8060/1810706-0002	SX195/008175871-0003
C324/006632071-0002	C370/2088880-0001	CB523/1035273-0002	P9900/000995576-0004	W100/003356278-0001
C325/006632071-0003	C371/2088880-0002	CB530/1890526-0008	P9901/000995576-0005	W101/003356278-0002
C326/006632071-0004	C372/2088880-0003	CB531/1890526-0009	PB513/1890526-0006	W102/003356278-0003
C327/006632071-0005	C373/002524769-0005	CX176/003242569-0009	PX147/002341727-0003	W103/003356278-0004
C335/000995576-0001	C374/002524769-0006	CX177/003242569-0010	PX169/002341727-0002	W105/004097780-0001
C336/1035273-0001	C380/003242569-0001	CX188/005329026-0004	PX175/003242569-0012	W106/005329026-0008
C338/1978214-0001	C381/003242569-0002	CX189/005329026-0005	PX198/008873806-0003	W107/005329026-0009
C338A/002341727-0007	C382/003242569-0003	CX190/005329026-0006	PX201/008873806-0005	W108/005329026-0010
C338B/002341727-0006	C383/003242569-0004	CX192/006632071-0006	PX202/008873806-0006	W109/006379848-0001
C339/1978214-0002	C390/003242569-0005	CX196/008873806-0001	R70/2088880-0006	W110/006379848-0002
C340/1978214-0003	C391/003242569-0006	CX197/008873806-0002	SX156/000995576-0006	W111/008175871-0004
C341/002524769-0001	C392/003242569-0007	CX199/008873806-0004	SX165/002341727-0001	W112/008175871-0005
C342/002524769-0002	C393/003242569-0008	CX203/008873806-0007	SX171/002920140-0001	W113/008175871-0006
C343/002524769-0003	C394/005329026-0001	DX168-2300/002341727-0004	SX172/003242569-0013	W114/008711071-0001
C344/002524769-0004	C395/005329026-0002	DX170/002524769-0008	SX173/003242569-0014	W116/008711071-0002
C351/000257464-0003	C396/005329026-0003	DX174-2300/003242569-0011	SX179/003242569-0015	W120/006632071-0009
C352/000257464-0004	C990/000995576-0002	DX182/004097780-0002	SX180/003242569-0016	W121/006632071-0010
C353/000257464-0005	C991/002524769-0007	DX183/004097780-0003	SX181/003242569-0017	W122/006632071-0011
C354/000257464-0006	CB500/1035273-0006	DX184/004097780-0004	SX185/004097780-0005	W123/006632071-0012
C355/000257464-0007	CB501/1035273-0005	P3020A/002341727-0005	SX186/004097780-0006	W130/006987111-0001
C356/000257464-0008	CB502/1035273-0007	P3070/2088880-0004	SX187/005329026-0007	
C361/1890526-0001	CB503/1890526-0005	P3071/2088880-0005	SX191/006632071-0008	
C362/1890526-0002	CB510/1035273-0004	P4025/006632071-0007	SX193/008175871-0001	
C363/1890526-0003	CB511/1035273-0003	P8050/000995576-0003	SX194/008175871-0002	

Guarantee terms and conditions apply if provided installation instructions have been followed to the letter. Fire retardant standards. In many interiors and projects strict fire regulations are imposed. Therefore, ORAC has implemented a number of solutions depending on the country and its regulations. Please contact us for more information. The information in this catalogue is without engagement. Changes and discrepancies in sizes or/and shapes against those stated in the catalogue can occur. This catalogue and the design embodied within are protected by copyright law and international treaties. Unauthorized reproduction of the catalogue, any portion of it or the reproduction of the designs embodied therein may result in severe civil and criminal penalties and will be prosecuted to the maximum. Further legal information can be found on: www.oracdecor.com/nl/disclaimer.



This catalogue is printed
on FSC-certified paper.

ORAC HEADQUARTERS

NV ORAC SA
Biekorfstraat 32
8400 Ostend, Belgium
T +32 59 80 32 52
info@oracdecor.com

ORAC BENELUX

Biekorfstraat 32
8400 Ostend, Belgium
NL: T 0800 022 2125
BeLux: T +32 59 80 32 52
benelux@oracdecor.com

ORAC DEUTSCHLAND

Boltensternstraße 159A
50735 Köln, Germany
T 0800 181 3694
deutschland@oracdecor.com

ORAC AUSTRIA

T 0800 292082
oesterreich@oracdecor.com

ORAC EXPORT

T +32 59 80 32 52
export@oracdecor.com

ORAC FRANCE

13 Rue Séguier
75006 Paris, France
T 0800 900 358
France@oracdecor.com

ORAC RUSSIA

249020, Россия, Калужская область,
Боровский район, Индустриальный парк Ворсино,
3-ий восточный проезд, строение 4
ООО «Орак»
T +7 495 799 70 60
info@oracdecor.ru

ORAC SLOVAKIA S.R.O.

Kpt. Nalepku 6
08271 Lipany - SK
T +421 514 891 581
slovakia@oracdecor.com

ORAC SPAIN

C/ Roger de Llúria 67-69 Pral 2ª
08009 Barcelona - ES
T 900 99 32 89
T +34 938 56 49 00
spain@oracdecor.com

ORAC (UK) LTD

Office: Unit 8, City Bus. Ctr.
6 Brighton Rd, Horsham RH13 5BB - UK
Showroom: Casala, 2 Sycamore St
London, EC1Y 0SF - UK
T +44 1403 240 102
uk@oracdecor.com